

# SOLUTIONS FOR HYBRID AND ELECTRIC VEHICLES OPERATIONS

2022 EDITION



EXPERT IN ELECTRICAL  
RISK PREVENTION

**CATU**<sup>TM</sup>

SICAME GROUP

---

# ROLLER CABINET FOR ELECTRIC AND HYBRID VEHICLES

---

Finally a complete solution to perform  
maintenance of electric and  
hybrid vehicles  
in total safety



**MO-RC-EV1**

CAN BE COMPLETED  
WITH SAFETY TOOL KITS

EXPERT IN ELECTRICAL  
RISK PREVENTION

[WWW.CATUELEC.COM](http://WWW.CATUELEC.COM)

**CATU**<sup>TM</sup>

SICAME GROUP



# CONTENT

<b>OVERVIEW OF ELECTRICAL OPERATIONS</b>	<b>4</b>
<b>GUIDE</b>	<b>7</b>
<b>PRODUCT CATALOGUE</b>	
<b>PPE / CPE</b>	<b>22</b>
<b>ROLLER CABINET</b>	<b>40</b>
<b>LIVE WORKING / DEAD WORKING</b>	<b>46</b>
<b>SIGNALING</b>	<b>65</b>
<b>LOCK-OUT / TAG-OUT</b>	<b>70</b>
<b>VOLTAGE DETECTORS AND MEASURES</b>	<b>74</b>
<b>KITS</b>	<b>80</b>



## VEHICLE LIFE CYCLE

Segment	Type of operations	Page
<b>Design</b>	Studies, Design, Testing, Alterations and Tests	8
<b>Manufacture</b>	Crash test – Homologation	9
<b>Maintenance</b>	Lock-out and Tag-out of electric vehicle	10
	Dead working on electric & hybrid vehicles after lock-out/tag-out operation	11
	Live working operations	12
	Operation on batteries (e. g. on power lift truck)	13
<b>Control</b>	Technical inspections	14
<b>Appraisal</b>	Vehicle appraisal	15
<b>Rescue and recovery</b>	Vehicle recovery operations, Towing	16
	Emergency Operations	17
<b>End of life</b>	Vehicle / Electric vehicle deconstruction operations	18

### 1 - DESIGN AND MANUFACTURE



#### Electrical hazard thresholds



- Direct current: nominal voltage difference greater than 60 V DC.
- Alternative current: potential difference greater than 25 V AC.
- Batteries: capacity greater than 180 Ah.

### 2 - MAINTENANCE





# OVERVIEW OF ELECTRICAL OPERATIONS VEHICLES AND MACHINES WITH ON-BOARD ELECTRICAL ENERGY SOURCE



**3 - CONTROL AND APPRAISAL**



**4 - RESCUE  
AND RECOVERY**



**5 - END OF LIFE**

# SHORT INSULATING GLOVES

CG-00-[\*]-R-28 AND CG-0-[\*]-R-28

**DEXTERI**   
Wellfit

IEC 60903: 2014  
EN 60903: 2003



## INSULATING GLOVES FOR A PERSONAL PROTECTION AGAINST AN ELECTRIC ARC DURING LIVE OPERATIONS.

- Class 00 (750 V DC) and Class 0 (1 500 V DC) insulating gloves.
- **Wellfit finish:** soft, supple, resistant and ergonomic with high flexibility for an easy daily work.
- Arc-Flash protection enhancing your safety.
- Battery acid resistance.
- Rolled cuff for comfort and ease of donning and doffing.
- Dedicated short over-gloves (CG-984-xx) for mechanical (EN 388) and fire protection (EN 407).

**MAXIMUM OPERATING VOLTAGE :  
750 V DC / 1 500 V DC**

**28 cm LENGTH, IDEAL FOR WORKING ON BATTERIES.**

Reference	↔ (mm)	Class	~	≡	ATPV (cal/cm <sup>2</sup> )	Box test	Category
CG-00-[*]-R-28	280	00	500 V AC	750 V DC	6	APC 1	AZC
CG-0-[*]-R-28	280	0	1 000 V AC	1 500 V DC	9	APC 2	RC

(\*) The reference will be completed with the size codes from 07 to 12.



# GUIDE

<b>DESIGN</b>	<b>8</b>
<b>MANUFACTURE</b>	<b>9</b>
<b>MAINTENANCE</b>	<b>10</b>
<b>CONTROL</b>	<b>14</b>
<b>APPRAISAL</b>	<b>15</b>
<b>ASSISTANCE AND REPAIRS</b>	<b>16</b>
<b>END OF LIFE</b>	<b>18</b>



**OPERATIONS**

- Short duration.
- Conduct Studies, Design, Testing and Alteration operations, after lock-out/tag-out or power switch-off.
- To install and uninstall vehicle components.
- Measurement of physical data in the vehicle.
- Check the equipment is in good order and monitor it.
- Carry out connection/disconnection operation of battery with voltage  $U \leq 60$  V DC or with capacity  $C \leq 180$  Ah. For higher values, refer to Live-working operations (page 12).



- It is forbidden to work without insulating gloves and without face shield in the vicinity of live energy sources.
- It is forbidden to use a measuring device to carry out a voltage absence check.

Products	Pages
Face shield	23
Helmet	23
Insulating gloves	25
Safety footwear with insulating sole	28
Insulating boots, insulating over shoes	29
Insulating protector, insulating blanket, sleeve, insulating mat	30,31
Arc-flash protective clothing	37
Insulated tools	46

Products	Pages
Signaling	65
Lock-out / Tag-out	70
Voltage detectors	74
Multimeters	76
Luggage	79
Additional tools: Rescue Pole, Kits	38
Extinguisher	39
Roller Cabinet	40

**OPERATIONS (AFTER CRASH TEST)**

- Identify damage of the electric vehicle.
- Assess HAZARDS (electrical, chemical, fire, etc.).
- Set up insulating protections to eliminate a RISK of voltage presence (installation of an insulating device such as an insulating blanket or a sleeve).
- Carry out and record all TEST measurements.
- Store and secure the vehicle. Tag it out in case of ELECTRICAL RISK.
- Carry out the connection/disconnection operation of battery of voltage  $U \leq 60 \text{ V DC}$  or with capacity  $C \leq 180 \text{ Ah}$ . For higher values, refer to Live-working operations (page 12).



- It is forbidden to work without insulating gloves and without face shield in the vicinity of live energy sources.
- It is forbidden to use a measuring device to carry out a voltage absence check.

Products	Pages
Face shield	23
Helmet	23
Insulating gloves	25
Safety footwear with insulating sole	28
Insulating boots, insulating over shoes	29
Insulating protector, insulating blanket, sleeve, insulating mat	30,31
Arc-flash protective clothing	37
Insulated tools	46

Products	Pages
Signaling	65
Lock-out / Tag-out	70
Voltage detectors	74
Multimeters	76
Luggage	79
Additional tools: Rescue Pole, Kits	38
Extinguisher	39
Roller Cabinet	40

## OPERATIONS

- Initiate the lock-out procedure.
- Identify the vehicle.
- Delineate and tag-out the working area.
- Isolate voltage sources.
- Lock-out all switches and elements in the “OFF” position.
- Check the absence of voltage.



- It is forbidden to work without insulating gloves and without face shield in the vicinity of live energy sources.
- It is forbidden to use a measuring device to carry out a voltage absence check.

Prior to the lock-out operation, select the adequate equipment for the planned operations:



Face shield, insulating gloves, voltage detector, padlock, safety boundary post and chain.

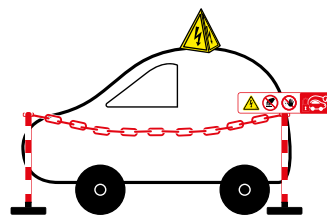

1) Identify the vehicle and delineate the work area.

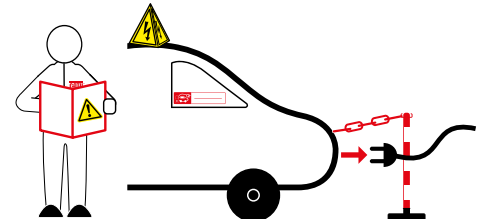

2) Isolate voltage sources.

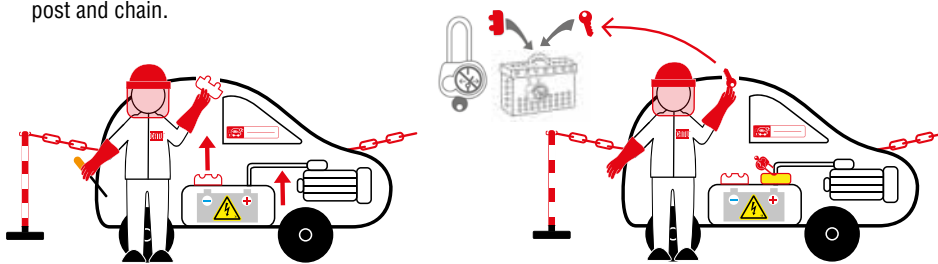

3) Lock in «OFF position»

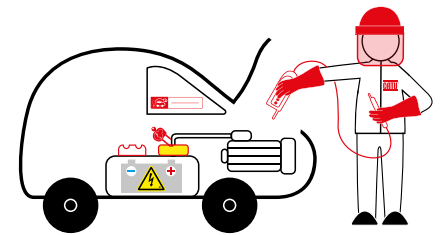

4) Check the absence of voltage at the connection terminals.



- It is forbidden to work without insulating gloves and without face shield in the vicinity of live energy sources.
- It is forbidden to use a measuring device to carry out a voltage absence check.

Products	Pages
<b>Face shield</b>	23
Helmet	23
<b>Insulating gloves</b>	25
Safety footwear with insulating sole	28
Insulating boots, insulating over shoes	29
<b>Insulating protector, insulating blanket, sleeve, insulating mat</b>	30,31
<b>Arc-flash protective clothing</b>	37
Insulated tools	46

Products	Pages
<b>Signaling</b>	65
<b>Lock-out / Tag-out</b>	70
<b>Voltage detectors</b>	74
<b>Multimeters</b>	76
Luggage	79
Additional tools: Rescue Pole, Kits	38
Extinguisher	39
Roller cabinet	40



OPERATIONS

- Work performed on the electrical equipment after voltage switch-off.
- Work carried out around the electrical equipment after voltage switch-off.
- Work carried out in vicinity of the electrical insulated cable sleeves.



- It is forbidden to work without insulating gloves and without face shield in the vicinity of live energy sources.
- It is forbidden to use a measuring device to carry out a voltage absence check.

Products	Pages
Face shield	23
Helmet	23
Insulating gloves	25
Safety footwear with insulating sole	28
Insulating boots, insulating over shoes	29
Insulating protector, insulating blanket, sleeve, insulating mat	30,31
Arc-flash protective clothing	37
Insulated tools	46

Products	Pages
Signaling	65
Lock-out / Tag-out	70
Voltage detectors	74
Multimeters	76
Luggage	79
Additional tools: Rescue Pole, Kits	38
Extinguisher	39
Roller cabinet	40

**OPERATIONS**

- Work in contact with live bare parts.
- Assemble elements to form a battery pack.
- Install/uninstall the battery pack(s) or batteries.
- Replace one or more battery cells.
- Maintain terminals, bare connections or battery housing.
- Disassemble a battery pack.
- Carry out operation on batteries with capacity  $C > 180 \text{ Ah}$  or voltage  $> 60 \text{ V DC}$ .

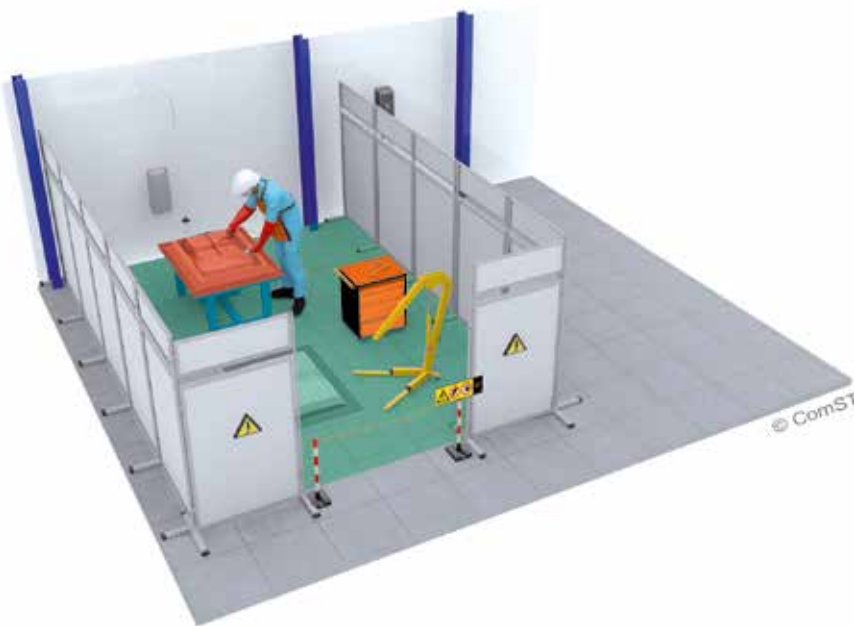

- It is forbidden to use a measuring device to carry out a voltage absence check.



Products	Pages
Face shield	23
Helmet	23
Insulating gloves	25
Safety footwear with insulating sole	28
Insulating boots, insulating over shoes	29
Insulating protector, insulating blanket, sleeve, insulating mat	30,31
Arc-flash protective clothing	37
Insulated tools	46

Products	Pages
Signaling	65
Lock-out / Tag-out	70
Voltage detectors	74
Multimeters	76
Luggage	79
Additional tools: Rescue Pole, Kits	38
Extinguisher	39
Roller cabinet	40

## OPERATIONS

### For BATTERIES:

- Make connection/disconnection operations.
  - Clean terminals and connectors.
  - Handle, check the batteries.
  - Check the electrolyte.
  - Clean the battery housing when the voltage is  $U > 60$  V DC.
  - Carry out connection/disconnection operations of battery with voltage  $U \leq 60$  V DC or with capacity  $C \leq 180$  Ah.
- For higher values, refer to Live-working operations (page 12).



© ComST

### For the SUPERCAPACITORS:

Connection/disconnection of SUPERCAPACITOR with bare parts.

### For fuel cells:

Measurement of the cell before connection/disconnection is allowed within the limit of VOLTAGE  $U \leq 60$  V DC. For higher values, refer to Live-working operations (page 12).



- It is forbidden to work without insulating gloves and without face shield in the vicinity of live energy sources.
- It is forbidden to use a measuring device to carry out a voltage absence check.



Products	Pages
Face shield	23
Helmet	23
Insulating gloves	25
Safety footwear with insulating sole	28
Insulating boots, insulating over shoes	29
Insulating protector, insulating blanket, sleeve, insulating mat	30,31
Arc-flash protective clothing	37
Insulated tools	46

Products	Pages
Signaling	65
Lock-out / Tag-out	70
Voltage detectors	74
Multimeters	76
Luggage	79
Additional tools: Rescue Pole, Kits	38
Extinguisher	39
Roller cabinet	40



**OPERATIONS**

- Make sure the vehicle is switched-off state during the inspection.
- Check the condition of electrical equipment, connectors, batteries, or battery pack(s) and loading interface.
- Check the integrity of the insulating components.
- Carry out the connection/disconnection operation of the battery with voltage  $U \leq 60$  V DC and with capacity  $C \leq 180$  Ah. For higher values, refer to Live-working operations (page 12).



- It is forbidden to work without insulating gloves and without face shield in the vicinity of live energy sources.
- It is forbidden to use a measuring device to carry out a voltage absence check.

Products	Pages
Face shield	23
Helmet	23
Insulating gloves	25
Safety footwear with insulating sole	28
Insulating boots, insulating over shoes	29
Insulating protector, insulating blanket, sleeve, insulating mat	30,31
Arc-flash protective clothing	37
Insulated tools	46

Products	Pages
Signaling	65
Lock-out / Tag-out	70
Voltage detectors	74
Multimeters	76
Luggage	79
Additional tools: Rescue Pole, Kits	38
Extinguisher	39
Roller cabinet	40

## OPERATIONS

- Assess the risk before the appraisal.
- Vehicle appraisal.



- It is forbidden to use a measuring device to carry out a voltage absence check.

Products	Pages
Face shield	23
Helmet	23
Insulating gloves	25
Safety footwear with insulating sole	28
Insulating boots, insulating over shoes	29
Insulating protector, insulating blanket, sleeve, insulating mat	30,31
Arc-flash protective clothing	37
Insulated tools	46

Products	Pages
Signaling	65
Lock-out / Tag-out	70
Voltage detectors	74
Multimeters	76
Luggage	79
Additional tools: Rescue Pole, Kits	38
Extinguisher	39
Roller cabinet	40

### OPERATIONS

#### On a broken down vehicle:

- Refer to the manufacturer instructions.
- Locate the electrical insulated cable sleeves in the event of lifting.
- Identify the short-circuit risks in the event of changing auxiliary battery.

#### On an accident-damaged vehicle:

- Analyse the risks.
- Ensure the safety of third parties.
- Identify the type of vehicle.
- Identify the damages to the vehicle.
- Power down the vehicle.
- Carry out connection/disconnection operation of the battery with voltage  $U \leq 60$  V DC or with capacity  $C \leq 180$  Ah. For higher values, refer to Live-working operations (page 12).



- It is forbidden to work without insulating gloves and without face shield in the vicinity of live energy sources.
- It is forbidden to use a measuring device to carry out a voltage absence check.



Products	Pages
Face shield	23
Helmet	23
Insulating gloves	25
Safety footwear with insulating sole	28
Insulating boots, insulating over shoes	29
Insulating protector, insulating blanket, sleeve, insulating mat	30,31
Arc-flash protective clothing	37
Insulated tools	46

Products	Pages
Signaling	65
Lock-out / Tag-out	70
Voltage detectors	74
Multimeters	76
Luggage	79
Additional tools: Rescue Pole, Kits	38
Extinguisher	39
Roller cabinet	40

**OPERATIONS**

- Assess the risks.
- Ensure the safety of third parties.
- Identify the damages to the charging device.
- Eliminate the risk of voltage presence in working area by placing the blanket and/or insulating protectors.
- Power down the charging device and the vehicle.
- Carry out the connection/disconnection operation of the battery with voltage  $U \leq 60 \text{ V DC}$  or with capacity  $C \leq 275 \text{ Ah}$ . For higher values, refer to Live-working operations (page 12).



- It is forbidden to work without insulating gloves and without face shield in the vicinity of live energy sources.
- It is forbidden to use a measuring device to carry out a voltage absence check.

Products	Pages
Face shield	23
Helmet	23
Insulating gloves	25
Safety footwear with insulating sole	28
Insulating boots, insulating over shoes	29
Insulating protector, insulating blanket, sleeve, insulating mat	30,31
<b>Arc-flash protective clothing</b>	37
Insulated tools	46

Products	Pages
Signaling	65
Lock-out / Tag-out	70
Voltage detectors	74
Multimeters	76
Luggage	79
Additional tools: Rescue Pole, Kits	38
<b>Extinguisher</b>	39
Roller cabinet	40



## OPERATIONS

- Assess the risk in case of presence of energy source.
- Park the vehicle in a protected area with warning signs.
- Check the absence of voltage after a permanent shutdown.
- Remove and store the batteries in a safe place.
- Carry out the connection/disconnection operation of the battery with voltage  $U \leq 60$  V DC or with capacity  $C \leq 275$  Ah. In the event of higher values, refer to the Live-working operations (page 12).



- It is forbidden to work without insulating gloves and without face shield in the vicinity of live energy sources.
- It is forbidden to use a measuring device to carry out a voltage absence check.

Products	Pages
Face shield	23
Helmet	23
Insulating gloves	25
Safety footwear with insulating sole	28
Insulating boots, insulating over shoes	29
Insulating protector, insulating blanket, sleeve, insulating mat	30,31
Arc-flash protective clothing	37
Insulated tools	46

Products	Pages
Signaling	65
Lock-out / Tag-out	70
Voltage detectors	74
Multimeters	76
Luggage	79
Additional tools: Rescue Pole, Kits	38
Extinguisher	39
Roller cabinet	40

# CATALOGUE ALPHABETICAL INDEX

<b>3/8"</b> Insulated tool set.....51	Insulated bi-material hexagonal screwdriver.....57	Pneumatic tester for insulating gloves.....27
3/8" Torx insulated socket.....50	Insulated bi-material phillips screwdriver.....56	PPE, locking and signaling equipment kit.....41
6 - 12 Sided insulating sockets.....49	Insulated bi-material pozidriv screwdriver.....56	Protective covers for helmets and visors.....24
6 Sides male socket.....48	Insulated bi-material torx screwdriver.....57	Protective equipment kit for live working.....41
	Insulated bits for MO-7200-DYN.....58	
	Insulated cable cutter.....54	
<b>AC</b> and DC voltage controller.....74	Insulated dead-blow hammer.....61	<b>R</b> atchets and accessories.....47
Adhesive plastic poster for HEV A4 format.....66	Insulated knives.....62	Rescue stick with insulated hook non removable...38
Adjustable torque wrench 3/8".....48	Insulated mirror.....61	Rescue wall kit.....45
Adjustable wrench.....55	Insulated ratchet wrench.....53	Roller cabinet for HEV operations.....40
Alumetal™ warning sign.....66	Insulated tools kit.....84	
Arc-Flash face shield with headband.....23	Insulating adaptor.....53	
	Insulating bag.....32	
	Insulating blanket.....31	<b>S</b> afety glasses.....22
<b>B</b> ackpack with wheels for electrician.....64	Insulating blanket class 0.....30	Safety over glasses.....22
Bags.....79	Insulating blanket class 0.....31	Safety padlock.....71
Bi-material insulated tools kit.....60	Insulating boots class 0.....29	Safety shoes with insulating.....28
Boundary post for delineation of a working area...67	Insulating brush.....61	Safety shoes with insulating sole, leather type.....28
	Insulating cap class 0.....33	Set of 40 temporary stickers "damaged vehicle" ..66
	Insulating device to lift up battery.....46	Signaling / delineation tape.....69
<b>C</b> arrying bag for blankets and.....36	Insulating mat class 0.....35	Sole, textile type.....28
Cat'arc multi-risk clothing.....37	Insulating mats.....36	Steering wheel cover.....72
Clamp for insulating blanket.....33	Insulating overboots class 1.....29	Storage boxes for accessories and tools.....63
Complete PPE kit for training.....82	Insulating pliers.....59	Strap for insulating mats.....36
Contact probes for I.V. detectors.....75	Insulating tool with wedge-shaped blade.....73	
	Insulation torque screwdriver.....58	<b>T</b> extile tool box.....62
	IP2X safety alligator clips.....78	T-handle wrench.....54
<b>D</b> elineation kit.....80	IP2X safety cords for test lead points.....77	Tool bag with reinforced base.....63
Digital multimeter.....76	IP2X safety test lead points and cords.....78	
<b>E</b> lastomer insulating apron.....34	<b>K</b> it for lock-out tag-out operations.....81	<b>U</b> ndergloves for insulating gloves.....27
Electrical insulating gloves: 28 cm.....25	Kit of 13 insulated tools.....44	
Electrical insulating gloves: 36 cm.....25	Kit of 17 insulated 3/8" square drive tools.....43	<b>W</b> renches and spanners.....52
Electrical plug lockout.....72	Kit of 28 insulated tools.....42	
Electrician helmet with integrated face shield.....23		
Electrician tool bag.....62	<b>L</b> eather overgloves.....26	
Essential PPE kit.....83	Live-working operations.....12	
Expander female to male.....47	Lockout station.....70	
Extinguisher for Li-ion battery.....39	Low voltage detector detex.....74	
<b>F</b> olding safety barrier.....67		
	<b>M</b> agnetic signal pyramid "electric hazard".....65	
<b>G</b> loves box and bag for insulating gloves.....27	Magnet on flexible handle.....60	
Group lock box.....70	Mechanical and Arc-Flash insulating gloves.....26	
<b>H</b> ead and hand protection kit.....85	<b>O</b> range insulating blanket class 0.....30	
Headlamp.....24	Oversized plug and hoist control lockout.....73	
HEV vehicle repair kit.....87		
	<b>P</b> arka "arc flash".....38	
<b>I</b> nfrared thermometer.....77	Plastic chain.....68	
Insulated bi-material flat blade screwdriver.....55	Plastic poster for HEV.....65	
	Plastic warning sign (set of 10 units).....71	

# REFERENCES INDEX

Reference	Page	Reference	Page	Reference	Page	Reference	Page	Reference	Page
ACA-10.....	65	KIT-VEH-C.....	81	MO-745D.....	61	MO-68108.....	52	MO-69003.....	55
AFG-1001-*.....	37	KIT-VEHC-TEC.....	85	MO-755D.....	61	MO-68109.....	52	MO-69005.....	55
AFG-2000-*.....	37	KIT-VEH-DEP.....	86	MO-810.....	46	MO-68110.....	52	MO-69025.....	48
AFG-2001-*.....	37	KIT-VEH-GEXP.....	88	MO-7200DYN.....	58	MO-68111.....	52	MO-69050.....	48
AFG-2300-*.....	37	KIT-VEH-GPRO.....	87	MO-7200-PH2.....	58	MO-68112.....	52	MO-69051.....	48
AL-31.....	68	KIT-VEH-PPE.....	83	MO-7200-PZ1.....	58	MO-68113.....	52	MO-69054.....	48
AL-31/05.....	68	KIT-VEH-PPE/02.....	82	MO-7200-PZ2.....	58	MO-68114.....	52	MO-69210.....	53
AL-31/25.....	68	KIT-VEH-V-TST.....	84	MO-7200-SL4.....	58	MO-68115.....	52	MO-69213.....	53
AL-32/05.....	68	M-87285.....	79	MO-7200-SL25.....	58	MO-68116.....	52	MO-69217.....	53
AL-32/25.....	68	M-87290.....	79	MO-7200-SL55.....	58	MO-68117.....	52	MO-69219.....	53
AL-139.....	69	M-87292.....	79	MO-7200-T15.....	58	MO-68118.....	52	MO-69306.....	49
AL-140.....	69	M-87303.....	62	MO-7200-T20.....	58	MO-68119.....	52	MO-69307.....	49
AL-316.....	67	M-87384.....	24	MO-7200-T25.....	58	MO-68120.....	52	MO-69308.....	49
AL-318.....	67	M-882452.....	63	MO-7582-D.....	60	MO-68121.....	52	MO-69308/23.....	51
AL-323.....	67	M-883374.....	38	MO-11000.....	22	MO-68122.....	52	MO-69309.....	49
AL-324.....	67	M-883377.....	38	MO-11001.....	22	MO-68123.....	52	MO-69310.....	49
AL-325.....	67	M-883378.....	38	MO-11010.....	22	MO-68124.....	52	MO-69311.....	49
AL-326.....	67	M-883379.....	38	MO-61001.....	62	MO-68125.....	52	MO-69312.....	49
AL-328.....	67	M-883380.....	38	MO-61002.....	62	MO-68126.....	52	MO-69313.....	49
ALPV-L-D.....	72	M-883381.....	38	MO-66000C.....	59	MO-68127.....	52	MO-69314.....	49
ALPV-XL-D.....	72	MO-39.....	62	MO-66303C.....	59	MO-68128.....	52	MO-69315.....	49
AM-20 GB.....	66	MO-42/1.....	63	MO-66404CC.....	59	MO-68129.....	52	MO-69316.....	49
AP-72.....	65	MO-42/2.....	63	MO-67501.....	54	MO-68130.....	52	MO-69317.....	49
AP-460.....	71	MO-43.....	79	MO-67502.....	54	MO-68132.....	52	MO-69318.....	49
AP-550-M2V.....	65	MO-44.....	64	MO-68006.....	52	MO-68206.....	52	MO-69319.....	49
AP-550-M3.....	65	MO-69T15.....	50	MO-68007.....	52	MO-68207.....	52	MO-69321.....	49
AT-81.....	66	MO-69T20.....	50	MO-68008.....	52	MO-68208.....	52	MO-69322.....	49
AT-5005.....	69	MO-69T25.....	50	MO-68009.....	52	MO-68209.....	52	MO-69323.....	49
ATP-551-B.....	66	MO-69T30.....	50	MO-68010.....	52	MO-68310.....	54	MO-69324.....	49
CD-307.....	39	MO-69T40.....	50	MO-68011.....	52	MO-68311.....	54	MO-69393.....	48
CG-00-* -R-28.....	25	MO-69T50.....	50	MO-68012.....	52	MO-68312.....	54	MO-69394.....	48
CG-0-* -R-28.....	25	MO-160.....	36	MO-68013.....	52	MO-68313.....	54	MO-69395.....	48
CG-10.....	25	MO-161.....	36	MO-68014.....	52	MO-68314.....	54	MO-69396.....	48
CG-35-2.....	27	MO-185-BL.....	23	MO-68015.....	52	MO-68316.....	54	MO-69397.....	48
CG-36-1.....	27	MO-286.....	23	MO-68016.....	52	MO-68317.....	54	MO-69398.....	48
CG-80-*.....	27	MO-600.....	73	MO-68017.....	52	MO-68319.....	54	MO-69408.....	49
CG-117.....	27	MO-694M04.....	48	MO-68018.....	52	MO-68321.....	54	MO-69409.....	49
CG-981-*.....	26	MO-694M05.....	48	MO-68019.....	52	MO-68322.....	54	MO-69410.....	49
CGM-0.....	26	MO-694M06.....	48	MO-68020.....	52	MO-68402.....	57	MO-69411.....	49
CS-45/2.....	38	MO-694M08.....	48	MO-68021.....	52	MO-68403.....	57	MO-69412.....	49
CZ-EV-RESC.....	45	MO-694M10.....	48	MO-68022.....	52	MO-68404.....	57	MO-69413.....	49
DX-02002.....	78	MO-694M12.....	48	MO-68023.....	52	MO-68405.....	57	MO-69414.....	49
DX-02003.....	77	MO-694M14.....	48	MO-68024.....	52	MO-68406.....	57	MO-69415.....	49
DX-02004.....	77	MO-694M17.....	48	MO-68025.....	52	MO-68408.....	57	MO-69416.....	49
DX-02006.....	78	MO-694M19.....	48	MO-68026.....	52	MO-68610.....	54	MO-69417.....	49
KIT-24.....	60	MO-698M03.....	48	MO-68027.....	52	MO-68613.....	54	MO-69418.....	49
KIT-RC-EPI-CO.....	41	MO-698M04.....	48	MO-68028.....	52	MO-68614.....	54	MO-69419.....	49
KIT-RC-PSA1.....	44	MO-698M05.....	48	MO-68029.....	52	MO-68620.....	54	MO-69421.....	49
KIT-RC-TOOL-3/8.....	43	MO-698M06.....	48	MO-68030.....	52	MO-68621.....	54	MO-69422.....	49
KIT-RC-TOOLS1.....	42	MO-698M07.....	48	MO-68032.....	52	MO-68713.....	54	MO-69423.....	49
KIT-RC-TST1.....	41	MO-698M08.....	48	MO-68106.....	52	MO-68714.....	54	MO-69424.....	49
KIT-VEH.....	80	MO-710-D.....	61	MO-68107.....	52	MO-68717.....	54	MO-69425.....	49

# REFERENCES INDEX

Reference	Page	Reference	Page	Reference	Page	Reference	Page	Reference	Page
MO-69426.....	49	MO-72004.....	55	MO-682141.....	52	MP-11/26.....	35	MP-635/50-D.....	33
MO-69427.....	49	MO-72005.....	55	MO-682151.....	52	MP-11/66.....	35	MP-635/60-D.....	33
MO-69428.....	49	MO-72006.....	55	MO-682161.....	52	MP-29/2-S.....	32	MS-124/2.....	24
MO-69429.....	49	MO-72008.....	55	MO-682171.....	52	MP-29/3-S.....	32	MS-415.....	74
MO-69430.....	49	MO-72010.....	55	MO-682181.....	52	MP-35.....	31	MS-917-L.....	74
MO-69432.....	49	MO-72030.....	56	MO-682191.....	52	MP-35/12.....	31	MS-918-L.....	74
MO-69512.....	47	MO-72032.....	56	MO-682211.....	52	MP-37.....	31	MS-8013.....	75
MO-69513.....	51	MO-72034.....	56	MO-682221.....	52	MP-40.....	31	MS-8014.....	75
MO-69522.....	47	MO-72036.....	56	MO-682231.....	52	MP-60/02-5.....	35	MV-99-INSD.....	34
MO-69522V.....	53	MO-72038.....	56	MO-693100.....	48	MP-60/02-10.....	35	MV-136J-*.....	29
MO-69523.....	51	MO-72040.....	56	MO-698055.....	49	MP-100/02-5.....	35	MV-138-*.....	29
MO-69536.....	47	MO-72042.....	56	MO-720510.....	57	MP-100/02-10.....	35	MV-222-*.....	28
MO-69537.....	47	MO-72042.....	60	MO-720515.....	57	MP-120/02-5.....	35	MV-223-*.....	28
MO-69540.....	47	MO-72044.....	56	MO-720520.....	57	MP-120/02-10.....	35	MV-226-*.....	28
MO-69804.....	49	MO-72046.....	56	MO-720525.....	57	MP-123.....	30	MV-227-*.....	28
MO-69805.....	49	MO-72048.....	56	MO-720527.....	57	MP-123/1.....	30	MX-701.....	76
MO-69806.....	49	MO-72056.....	57	MO-720530.....	57	MP-123/2.....	30	MX-704.....	77
MO-69807.....	49	MO-72057.....	57	MO-720540.....	57	MP-220.....	30	PL-100.....	72
MO-69808.....	49	MO-72058.....	57	MO-720545.....	57	MP-220/1.....	30	PL-101.....	72
MO-69809.....	49	MO-72059.....	57	MO-720550.....	57	MP-625-D.....	33	PL-102.....	73
MO-69810.....	49	MO-72142.....	60	MO-RC-EV1.....	40	MP-627-D.....	33	PM-4-38-R-Z.....	71
MO-69811.....	49	MO-72172.....	60	MP-01.....	36	MP-635/10-D.....	33	PM-6-38-R-Z.....	71
MO-69812.....	49	MO-72200.....	60	MP-02.....	36	MP-635/15-D.....	33	PP-4-38-R-Z (*).....	71
MO-69813.....	49	MO-682101.....	52	MP-11/11.....	35	MP-635/20-D.....	33	PP-6-38-R-Z.....	71
MO-69814.....	49	MO-682111.....	52	MP-11/16.....	35	MP-635/25-D.....	33	SL-101.....	70
MO-72002.....	55	MO-682121.....	52	MP-11/21.....	35	MP-635/30-D.....	33	SL-102.....	70
MO-72003.....	55	MO-682131.....	52	MP-11/22.....	35	MP-635/40-D.....	33	SL-106.....	70





## PPE / CPE EYE PROTECTION

EN 166 / EN 170



**NEW!**



MO-11000

### SAFETY GLASSES

**Use:**

- Ensure the eyes protection against the impact of high-speed solid particles.
- Not adapted for welding operations.

**Features:**

- "Soft-flex" ear pieces guaranteeing low pressure fit.
- Delivered in a pouch.



MO-11001

Reference	Color	Resistance	
MO-11000	Transparent	Level F	24
MO-11001	Tinted	Level F	24



**DELIVERED IN POUCH**

EN 166 / EN 170



MO-11010

### SAFETY OVER GLASSES

**Use:**

- Ensure the protection of the eyes against the impact of high-speed solid particles.

**Features:**

- Fit over prescription eye glasses.
- Delivered in a pouch.

Reference	Color	Resistance	
MO-11010	Transparent	Level F	45



MO-286



### ARG-FLASH FACE SHIELD WITH HEADBAND

**Use:**

- Protective face shield against short-circuit electric arcs.
- To wear without helmet.
- Head adjustment by a ratchet.

**Features:**

- Anti-scratch and anti-fogging treatments.
- Screen height: 20,5 cm.

Reference	Box test	 mm.	
MO-286	APC 1	270 x 260 x 200	0,40



MO-185-BL



### ELECTRICIAN HELMET WITH INTEGRATED FACE SHIELD

**Application :**

- Head protection : mechanical protection and insulating protection in case of contact with live parts.
- Face protection against heat hazard of an arc flash APC1.

**Features :**

- Arc flash face shield totally retractable inside the helmet. Height of the screen 18 cm.
- Anti-scratch and anti-fogging face shield.
- Adjustable head band thanks to the ratchet.

Reference	 mm.	
MO-185-BL	340 x 270 x 190	0,75



## HEADLAMP



MS-124/2

### Application:

- Headlamp for helmets MO-185, MO-180-ARC and MO-182/1.
- Compatible with most of the helmets on the market.

### Features:

- 3 lighting mode: Max, Mini and flashing signal.
- Orientable.
- Large autonomy: 100 hours in full power.
- Light distance at full power: 35 m.
- Maximum light output: 70 lm
- Supplied with support to fix on helmet: 1 universal adhesive.

Reference	Characteristics	Protection index	 g
MS-124/2	Waterproof	IPX4	68

## PROTECTIVE COVERS FOR HELMETS AND VISORS



M-87384

Reference	Description	 mm.
M-87384	To protect helmet (or visor) during transport	Ø 435 (aperture) x 440



CG-00-R-28

### ELECTRICAL INSULATING GLOVES: 28 CM

- Wellfit finish: soft, supple, resistant and ergonomic with high flexibility for an easy daily work.
- Insulating gloves adapted for Electric and Hybrid Vehicles operations: Arc-Flash protection. Battery acid resistance.

Reference	Class	ATPV (cal/cm <sup>2</sup> )	Box test		(mm)	Category	Sizes
CG-00-* <b>-R-28</b>	00	6	APC 1	750 V DC	280	AZC	07-12
CG-0-* <b>-R-28</b>	0	9	APC 2	1 500 V DC	280	RC	07-12



To be used with **CG-981**  
for **CG-10** and **CG-984**  
for **CG-XX-R-28**  
**EXTRA-MECHANICAL PROTECTION**



### ELECTRICAL INSULATING GLOVES: 36 CM

- Wellfit finish: soft, supple, resistant and ergonomic with high flexibility for an easy daily work.



CG-10..

Reference	Class		(mm)	Category	Sizes
CG-10	0	1 500 V DC	360 mm	RC	07-12







### MECHANICAL AND ARC-FLASH INSULATING GLOVES: 36 CM



CGM-0..

- Electrical insulating gloves with mechanical resistance.
- Wellfit finish: soft, supple, durable and ergonomic with high flexibility to ease the work.
- Protection against thermal hazards from an electric arc ATPV 12 cal/cm<sup>2</sup>, APC 2 (box test 7 kA) as a standard.

Reference	Class		ATPV (cal/cm <sup>2</sup> )		Category	Sizes
CGM-0	0	1 500 V DC	12	360 mm	RC	07-12



EN 388:2016 / EN 420 +A1:5 / EN 407:2004



### LEATHER OVERGLOVES FOR LOW VOLTAGE INSULATING GLOVES



CG-981...

#### Application:

- The overgloves ensure mechanical protection for insulating gloves (class 00 & 0).
- Resistant to flame and contact heat of 100 ° C for 10 s according to EN 407.
- Velcro® at the cuff adjusts the tightness of the glove to the user's hand.



CG-984

Reference	Sizes	Description	
CG-981-*	08-12	For gloves CG-10	310
CG-984	07-12	For short gloves CG-XX-R-28	250

\* Reference to be completed by size



CG-80-H

### UNDERGLOVES FOR INSULATING GLOVES

**Application:**

- Washable undergloves improve the comfort of use and hygiene of insulating gloves.

**Composition:**

- Packaging : 5 pairs per plastic bag with an instruction for use.

Reference	Sizes	
CG-80-*	H = Man F = Woman	28

\* Reference must be completed with H (Male model) or F (Female model)



CG-117

### PNEUMATIC TESTER FOR INSULATING GLOVES

**Application:**

- For compulsory control of insulating gloves before use.
- Device recommended by standard IEC 60903:2014 for the periodic testing of insulating gloves from class 00 to 4

Reference	Description	
CG-117	Pneumatic tester for insulating gloves	700



CG-35-2





CG-36-1

### GLOVES BOX AND BAG FOR INSULATING GLOVES

**Application:**

- Ensure to the gloves a good mechanical protection against shocks and UV radiation.
- Box can be fixed on a wall, in a substation, or be used as a carrying box and a storage box.

Reference	Composition	 mm	
CG-35-2	Box	476 x 224 x 101	900
CG-36-1	Bag	420 x 180 x 50	180



### SAFETY SHOES WITH INSULATING SOLE, LEATHER TYPE



MV-222-\*

**Application:**

- Safety shoes, leather type, conform to ASTM F2413:2018 Electrical Hazard resistance 18 kV.
- To be used inside or in a dry environment.
- Safety shoes with insulating sole specifically designed for the electricians, industry, building , oily and smooth soils.
- Individually tested (dielectric test).

Reference	Class	Size
MV-222-*	0	39 - 47
MV-223-*	0	39 - 47

\* Complete the reference with the size. Ex: MV-222-43



MV-223-\*



### SAFETY SHOES WITH INSULATING SOLE, TEXTILE TYPE



MV-226-\*

**Application:**

- Safety shoes, textile type, Conform to ASTM F2413:2018 Electrical Hazard resistance 18 kV.
- To be used inside or in a dry environment.
- Safety shoes with insulating sole specifically designed for the electricians, industry, building, oily and smooth soils.
- Individually tested (dielectric test).

Reference	Class	Size
MV-226-*	0	40-47
MV-227-*	0	40-47

\* Complete the reference with the size. Ex: MV-227-43



MV-227-\*



CE 0120 / EN ISO 20345  
EN 50321-1:2018, ASTM F2413-05,  
ASTM F1117-93 and CSA Z195-02



MV-136J...

### INSULATING BOOTS CLASS 0 (1 000 V AC), TESTED 5 KV

**Application :**

- Insulating boots provide electrical insulating protection against step voltage.
- Class 0: 1 000 V AC / 1 500 V DC.
- Design to prevent clogging.

Reference	Class	Size
MV-136J-*	0	39-49

\* Complete the reference with the size. Ex: MV-136J-43

EN 50321-1:2018  
ASTM 1117



### INSULATING OVERBOOTS CLASS 1 (7 500 V AC), 10 KV TESTED

**Application:**

- The overboots offer an electric insulation protecting the operator against the risks of step voltage on the ground or a current circulating between the feet and the ground.
- Ideal for temporary and frequent use.
- Fit perfectly over safety shoes allowing live working up to 7.5 kV AC with every boot tested to 10 kV AC.
- Rubber sole promoting a superior slip resistance.



MV-138..

Reference	Size
MV-138-*	M (39-42) L (43-45) XL (46-49)

\* Complete the reference with the size. Ex: MV-138-L





MP-123



## INSULATING BLANKET CLASS 0

### Application:

- Used as protection for workers operating on live parts or in the vicinity of live parts.
- Operating voltage: 1 000 V AC - 1 500 V DC.

### Features:

- In accordance with IEC 61112 class 0 standard and the specific properties:
  - Category A : Acid resistance.
  - Category C : Resistance to bending at very low temperature (-40°C).
  - Category H : Oil resistance.
- Fibers reinforced PVC material.
- Gripping tape (Velcro® type) all around the blanket for fixation or fitting with another blanket.
- Operating temperature range : -40°C to +55°C.
- High puncture resistance.

Reference	Class	mm.	Thickness mm	kg
MP-123	0	360 x 660	0.5	160
MP-123/1	0	500 x 900	0.5	270
MP-123/2	0	800 x 1 200	0.5	570



## ORANGE INSULATING BLANKET CLASS 0

### Application:

- Used as protection for workers operating on live parts or in the vicinity of live parts.
- Operating voltage: 1 000 V AC - 1 500 V DC.

### Features:

- In accordance with IEC 61112 class 0 standard and the specific properties:
  - Category C : Resistance to bending at very low temperature (-40°C).
  - Category H : Oil resistance.
- Orange elastomeric material.
- Operating temperature range : -40°C to +55°C.
- High puncture resistance.



MP-220

Reference	Class	mm.	Thickness mm	kg
MP-220	0	1 000 x 1 000	1.2	1.5
MP-220/1	0	1 000 x 10 000	1.2	15



### INSULATING BLANKET CLASS 0



MP-37

**Application:**

- Insulating blanket for workers operating on live parts or in the vicinity of live parts.
- Operating voltage: 1 000 V AC - 1 500 V DC.

**Features:**

- In accordance with IEC 61112 class 0 standard and the specific properties:
  - Category A : Acid resistance.
  - Category C : Resistance to bending at very low temperature (-40°C).
  - Category H : Oil resistance.
  - Category Z : Ozone resistance.
- Operating temperature range : -40°C to +55°C.

Reference	Class	mm.	Thickness mm	kg
MP-35	0	1 300 x 25 000	0.3	12
MP-35/12	0	1 300 x 12 500	0.3	6
MP-37	0	90 x 25 000	0.3	0.8



MP-40



### INSULATING BLANKET

**Application:**

- Operating voltage: 1 000 V AC - 1 500 V DC
- Used as protection for workers operating on live parts or in the vicinity of live parts.

**Features:**

- In accordance with SERECT ST HTA 50D standard.
- Translucent flexible plastic material.

Reference	mm.	Thickness mm	kg
MP-40	1 300 x 25 000	0.8	24



MP-29/2-S



MP-29/3-S



## INSULATING BAG

### Application:

- Insulating bag for live working on low voltage network or installation.
- They are used to cover live parts as connectors on cable ends.
- Maximum operating voltages: 1 000 V AC - 1 500 V DC.

### Features:

- In accordance with NF C 18-425 standard and SERECT TST BT N°455 specification.
- Flexible thermoplastic material.
- Waterproof on 3 sides. Closing by strap “Velcro” type on the open side.
- Hole at the base of the bag for gripping with hook pole in the case of distance method working.
- 2 sizes available.

Reference	Material	 mm.	 g
MP-29/2-S	PVC	215 x 136	100
MP-29/3-S	PVC	225 x 305	160



MP-625-D



### CLAMP FOR INSULATING BLANKET

**Application:**

- Insulating clamp for LV blankets fixation.

**Features :**

- Compliant with DIN VDE 0680-1 standard.
- Maximum operating voltage: 1 000 V AC - 1 500 V DC.
- Entirely insulating.
- Non-slip nose.

Reference	←→ mm.		
MP-625-D	165	1	70
MP-627-D	80	3	30



MP-627-D



MP-635/30-D

### INSULATING CAP CLASS 0

**Application :**

- The insulating caps are used for temporary insulation of LV cable bare extremities.

**Features :**

- Maximum operating voltage : 1 000 V AC - 1 500 V DC.

Reference	←→ mm		
MP-635/10-D	75	10 mm	10
MP-635/15-D	100	15 mm	15
MP-635/20-D	100	20 mm	20
MP-635/25-D	110	25 mm	30
MP-635/30-D	120	30 mm	40
MP-635/40-D	135	40 mm	55
MP-635/50-D	155	50 mm	65
MP-635/60-D	140	60 mm	105







## ELASTOMER INSULATING APRON

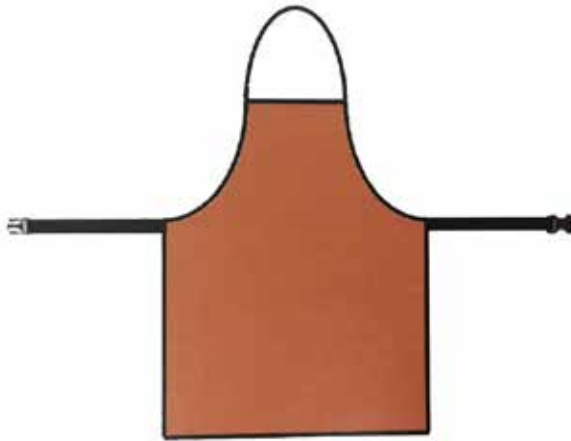

MV-99-INSD

### Application:

- Orange colored elastomer insulating apron used to insulate insufficiently insulated conductive parts during the work.

### Features:

- The material is also in compliance with special properties:
  - Category A: acid-resistant.
  - Category C: can be folded at very low temperature (-40°C).
  - Category H: oil-resistant.
- High resistance to perforation.
- Adjustable belt strap with plastic lock.
- Insulator's height: 65 cm. Width: 50 cm.
- Thickness: 1.2 mm.

Reference



 mm.

MV-99-INSD

1 500 V DC

650 x 500



## INSULATING MAT CLASS 0 – WIDTH 1 M





MP-11/16

### Application :

- Operating voltage : 1 000 V AV - 1 500 V DC.
- Insulating mat for live line work and dead work.
- Floor covering for the electrical protection of workers in electrical installations.
- Protect the workers from the ground potential.

### Features :

- In accordance with IEC 61111 standard and to specific properties of the “C” Category (extremely low temperature folding test at – 40 °C).
- RoHS2 and REACH compliant (SVHC free).
- D bar code (Datamatrix) on marking with direct link to user guide and technical sheet.
- Storage temperature: +10°C to +21°C.
- Operating temperature: -40°C to +55°C.

Reference	Class	 mm	 m	 kg
MP-11/66	0	2.2	0,6 x 0,6	1
MP-11/16	0	2.2	0,6 x 1	1,8
MP-11/26	0	2.2	0,6 x 1,2	2
MP-11/11	0	2.2	1 x 1	3
MP-11/21	0	2.2	1 x 1,2	3,4
MP-11/22	0	2.2	1,2 x 1,2	4
MP-60/02-5	0	2.2	0,6 x 5	9
MP-60/02-10	0	2.2	0,6 x 10	18
MP-100/02-5	0	2.2	1 x 5	15
MP-100/02-10	0	2.2	1 x 10	30
MP-120/02-5	0	2.2	1,2 x 5	17
MP-120/02-10	0	2.2	1,2 x 10	34



MO-160



MO-161



## STRAP FOR INSULATING MATS

### Application:

- Helps to keep the insulating mat in a rolled up position and facilitates storage.

### Features:

- Instruction manual for insulating mat printed on the strap - pictograms and texts in French and English.

Reference	 mm.	 g
MO-160	530 x 38	100
MO-161	1 700 x 38	200



## CARRYING BAG FOR BLANKETS AND INSULATING MATS

### Application:

- Particularly suitable for transporting blankets and insulating mats.



MP-01

Reference	Use	 mm.	 kg
MP-01	For MP-11/16, MP-11/66, MP-11/26	700	0.35
MP-02	For MP-11/11, MP-11/21	1 230	0.42



IEC 61482-2 APC 1 & ATPV 12 cal/cm<sup>2</sup>  
ISO 11612 A B1 C1 E2 F ISO 11611\* classe 1  
EN 1149-5 NFPA 70E - ASTM F1959



### CAT'ARC MULTI-RISK CLOTHING TO PROTECT AGAINST AN ELECTRIC ARC

**Application:**

- Multi-risk protection: protection against thermal hazards of an electric arc, ATPV 12 cal / cm<sup>2</sup>, APC 1, heat and flames, welding hazards and being antistatic.

**Features:**

- Hard-wearing garment: knees and crotch reinforcements.



AFG-2300-\*

AFG-1001-\*

Reference	Composition	Size
AFG-2000-*	Jacket	XS - 5XL
AFG-2001-*	Trousers	XS - 5XL
AFG-1001-*	Coverall	XS - 5XL
AFG-2300-*	Switching jacket	S, L, 2XL, 4XL

\* Not concerned AFG-2300-\*



Anti-panic zip to improve your safety in case of accident.





M-883374

### HIGH VISIBILITY MULTI-RISK PARKA FOR PROTECTION AGAINST AN ELECTRIC ARC

**Application:**

- Multi-risk protection : hight-visibility, rain protection, protection against thermal hazards of an electric arc, heat and flams, being anti-static, small splash of liquids chemicals.

Reference	Color	Size
AFG-PARKA-S	HV orange/navy blue	S
AFG-PARKA-M	HV orange/navy blue	M
AFG-PARKA-L	HV orange/navy blue	L
AFG-PARKA-XL	HV orange/navy blue	XL
AFG-PARKA-2XL	HV orange/navy blue	2XL

### RESCUE STICK WITH INSULATED HOOK NON REMOVABLE

**Application:**

- The rescue stick is suitable for use with a voltage of 45 kV or less.
- The rescue stick is used, in the context of an electric shock, to safely remove the dangerous elements from the accident area.
- Rescue stick is compliant with CATU STC n° 43.

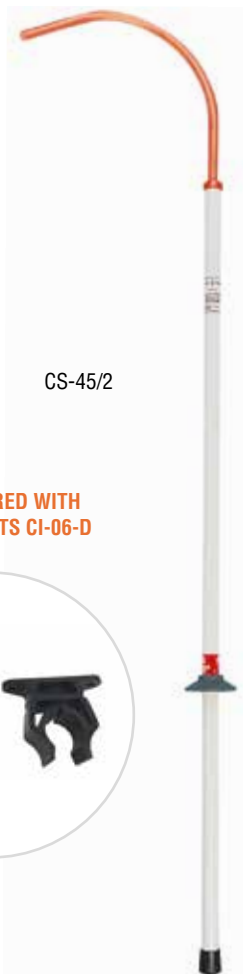

CS-45/2

STICK DELIVERED WITH WALL BRACKETS CI-06-D



Reference				
CS-45/2	45 kV	67 kV	1 650	1



**NEW!**



CD-307

## EXTINGUISHER FOR LI-ION BATTERY

### Application:

- Portable fire extinguisher for Li-ion battery fire.
- Can be used on batteries with a maximum voltage of 1 000 V AC - 1 500 V DC.

### Features:

- Fire class A.
- Liquid with aditif for li-ion batteries.
- Capacity: 3 liters.
- Limits the smoke formation.
- Maximum operating distance : 4 m.
- Duration of continuous spraying: 12 s.
- Service life 10 years.

Reference

 mm.



CD-307

410 x Ø 230

6



## LIVE WORKING / DEAD WORKING ROLLER CABINET AND KITS

**NEW!**



### ROLLER CABINET FOR HYBRID AND ELECTRIC VEHICLE OPERATIONS

**Application:**

- Roller cabinet for hybrid and electric vehicle operations. Allows to store all the necessary equipment: PPE, locking - signaling equipment and insulated tools in one place.

**Features:**

- Maximum load: 850 kg (Static).
- ABS Tray with Metal board and ATP-551-B Sign: "HEV Golden Rules"
- 2 drawers: 74 mm height each
- 2 drawers: 132 mm height each
- 1 drawer: 272 mm height
- Storage for boundary posts (up to 6 units Ø 5 cm, not included)
- 4 wheels, 2 fixed and 2 steering with brake
- 100% steel epoxy painted



MO-RC-EV1

Reference

mm.

kg

MO-RC-EV1

1 359 x 973 x 481

50



- To complement the roller cabinet, select the kit meeting your operation:



	Trade	Vehicle repair	Represent active vehicle repair	MOT or technical control	Paint & body repair	Dealer	Training agency
Operation	Roller cabinet	MO-RC-EV1	•	•	•	•	•
Operation	Delineation Lock-Out Essential set for personal protection	KIT-RC-EPI-CO	•	•	•	•	•
Operation	Work in the vicinity or under voltage Insulating items	KIT-RC-TST1		•	•	•	•
Operation	Live working with essential tools	KIT-RC-TOOLS1				•	•
Operation	Live working with tools to improve your productivity	KIT-RC-TOOLS-3/8				•	•
Operation	Lock-Out for PSA vehicle (tools)	KIT-VEH-PPE/02	•	•	•		



## PPE, LOCKING AND SIGNALING EQUIPMENT KIT

### Application:

- PPE, locking and signaling equipment kit for all the maintenance operations on HEV.



KIT-RC-EPI-CO

Reference	Comp.	Quantity	Description
	AL-323	4	Safety boundary posts
	AL-31/25	25 m	Plastic chain delineators
	MO-286	1	Arc-flash shield with bandhead
	M-87-384	1	Protection bag for Arc-flash shield
	CGM-0-10	1	Rubber insulating gloves with mechanical and Arc-Flash (ATPV 12 cal/cm <sup>2</sup> , APC 2) protection, Size: 10, Class 0 (1 000 V AC - 1 500 V DC)
	ACA-10	1	3-sided magnetic warning pyramid
	AL-43	1	Textile red tape delimitators
	MS-917-PG	1	Voltage detector. Operating range from 12 to 900 V AC and from 12 to 1 000 V DC
	PP-4-38-RZ	1	Plastic padlock with a Ø 4 mm insulating nylon shackle



KITS FOR ROLLER CABINET

## PROTECTIVE EQUIPMENT KIT FOR LIVE WORKING

### Application:

- For live working operation at maximum voltage of 1 000 V AC – 1 500 V DC.
- For operator protection against live conductors and connectors.
- Kit also recommended for paint and body repair workshops and road assistance.



KIT-RC-TST1

Reference	Comp.	Quant.	Description
	MP-220	1	Insulating blanket 1 m X 1 m, class 0
	MP-627-D	4	Insulating clamps 80 mm for blanket
	MP-635/30-D	3	Insulating caps Ø 30 X 120 mm, class 0
	MP-635/60-D	3	Insulating cap Ø 40 X 135 mm, class 0



KITS FOR ROLLER CABINET





## KIT OF 28 INSULATED TOOLS IEC 60900:2018

### Application:

- Maximum operation voltage: 1 000 V AC – 1 500 V DC.
- Contains the insulated tools for live working operations on HEV. Supplied with a foam storage module with machined tool supplied.



KIT-RC-TOOLS1

Reference	Comp.	Quant.	Description
MO-65204		1	Insulated Flat blade screwdriver 3,5 X 100 mm, 1 000 V AC – 1 500 V DC, IEC 60900:2018
MO-65206		1	Insulated Flat blade screwdriver 5,5 X 100 mm, 1 000 V AC – 1 500 V DC, IEC 60900:2018
MO-65242		1	Insulated POZIDRIV screwdriver n°1, 4,5 X 80 mm, 1 000 V AC – 1 500 V DC, IEC 60900:2018
MO-65244		1	Insulated POZIDRIV screwdriver n°2, 6 X 100 mm, 1 000 V AC – 1 500 V DC, IEC 60900:2018
MO-65246		1	Insulated POZIDRIV screwdriver n°3, 8 X 150 mm, 1 000 V AC – 1 500 V DC, IEC 60900:2018
MO-66001		1	Insulated universal pliers 160 mm ,1 000 V AC – 1 500 V DC, IEC 60900:2018
MO-66402		1	Insulated bent nose pliers 160 mm, 1 000 V AC – 1 500 V DC, IEC 60900:2018
MO-66505		1	Insulated multigrip pliers 1 000 V AC – 1 500 V DC, IEC 60900:2018
MO-67102		1	Insulated cutting plier, 1 000 V AC – 1 500 V DC, IEC 60900:2018
MO-6990.		6	Insulated set of 6 bented male hexagonal wrenches from 3 mm to 8 mm, 1 000 V AC – 1 500 V DC, IEC 60900:2018
MO-680..		5	Insulated set of 5 open-end spanners size 8, 9, 10, 11 and 13 mm, 1 000 V AC – 1 500 V DC, IEC 60900:2018
MO-681..		7	Insulated set of 7 ring spanners size 8, 10, 11, 12, 13, 14 and 16 mm, 1 000 V AC – 1 500 V DC, IEC 60900:2018
MO-7582-D		1	Insulated magnet with flexible extension and handle 1 000 V AC – 1 500 V DC, IEC 60900:2018
MO-FT-01		1	Tool storage foam tray

### KIT-RC-TOOLS1



KITS FOR  
ROLLER  
CABINET



KIT-RC-TOOLS-3/8

### KIT OF 17 INSULATED 3/8” SQUARE DRIVE TOOLS IEC 60900:2018

**Application:**

- Maximum operation voltage: 1 000 V AC – 1 500 V DC. 3/8 ” insulated tightening tool kit offering productivity and safety for live working on HEV and batteries.

Reference	Comp.	Quant.	Description
	MO-69513	1	Insulated 3/8” Ratchet wrench, length: 190 mm, 1 000 V AC – 1 500 V DC, IEC 60900:2018
	MO-69523, MO-69533	2	Insulated 3/8” 140 mm and 264 mm extension bar, 1 000 V AC – 1 500 V DC, IEC 60900:2018
KIT-RC-TOOL-3/8	MO693..	9	9 insulated 3/8” 6 sided socket set, 1 000 V AC – 1 500 V DC, EC 60900:2018, (Size: 8, 9, 10, 11, 12, 13, 14, 15, 16 mm)
	MO6939.	5	5 insulated 3/8” hexagonal male socket set 1 000 V AC – 1 500 V DC, IEC 60900:2018, (Size: 4, 5, 6, 7, 8 mm)
	MO-FT-02	1	Tool storage foam tray



KITS FOR ROLLER CABINET

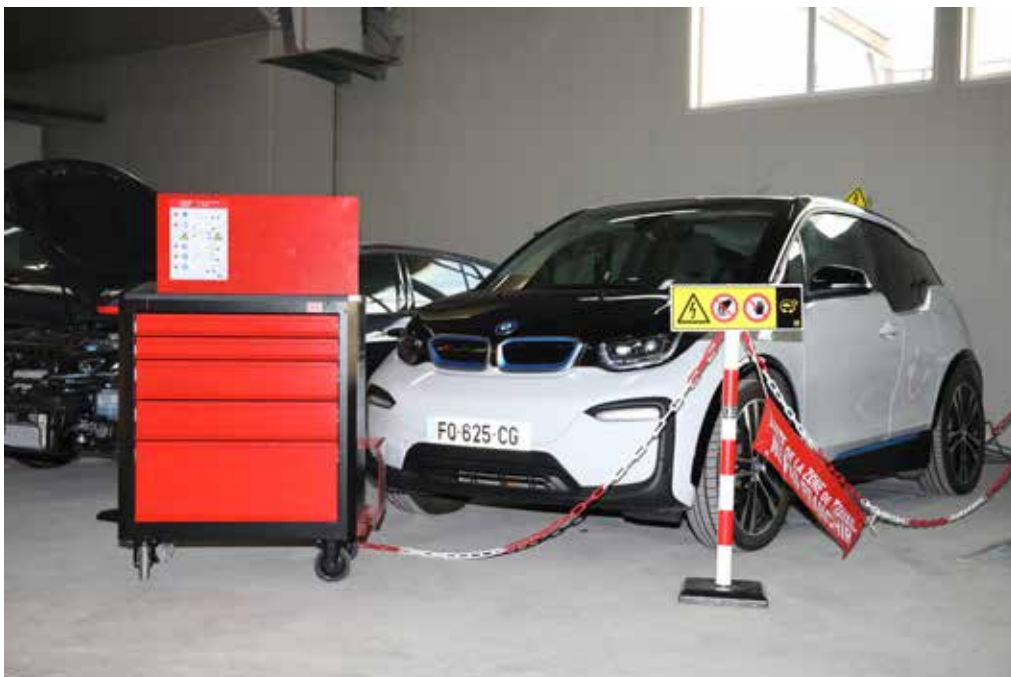



KIT-RC-PSA1

## KIT OF 13 INSULATED TOOLS 1 000 V AC – 1 500 V DC IEC 60900:2018

### Application :

- For live working operation at maximum voltage of 1 000 V AC – 1 500 V DC.
- To Lock-Out PSA vehicles like the CITROEN C-Zero and Peugeot iOn.
- Including a tool storage foam tray.

Reference	Comp.	Quant.	Description
	MO-65206	1	Insulated flat screwdriver 5.5 X 100 mm 1 000 V AC – 1 500 V DC, IEC 60900:2018
	MO-65244	1	Insulated POZIDRIV screwdriver n°2, 6 X 100 mm, 1 000 V AC – 1 500 V DC, IEC 60900:2018
	MO-681..	2	Insulated offset wrenches 10 and 12 mm, 1 000 V AC – 1 500 V DC, IEC 60900:2018
KIT-RC-PSA1	MO-69513	1	Insulated 3/8" Ratchet wrench, length: 190 mm, 1 000 V AC – 1 500 V DC, IEC 60900:2018
	MO-69523, MO-69533	2	Insulated 3/8" 140 mm and 264 mm extension bar, 1 000 V AC – 1 500 V DC, IEC 60900:2018
	MO693..	6	6 x insulated 3/8" 6 sides socket set 1 000 V AC – 1 500 V DC, IEC 60900:2018, Size: 8, 10, 11, 12, 13 and 14 mm
	MO-FT-03	1	Tool storage foam tray



KITS FOR ROLLER CABINET



CZ-EV-RESC

## RESCUE WALL KIT FOR AUTOMOTIVE MAINTENANCE AND BODY REPAIR SHOPS

### Application:

- Rescue wall kit for automotive maintenance and body repair shops. For interventions in the event of an electrical hazard or fire.
- Wall support accessories included.

Reference	Comp.	Quant.	Description
	CS-45/2	1	Rescue stick with insulated hook
	CG-35-2	1	Wall box for insulating gloves
CZ-EV-RESC	CGM-0-10	1	Rubber insulating gloves with mechanical and Arc-Flash (ATPV 12 cal/cm <sup>2</sup> , APC 2) protection, Size: 10, Class 0 (1 000 V AC - 1 500 V DC)
	CD-307	1	Fire extinguisher for this Li-ion battery



KITS FOR ROLLER CABINET





## LIVE WORKING / DEAD WORKING INSULATED TOOLS



MO-810

Ultimate safety protection:  
There is no electrical continuity between the 2 battery fixing screws and the lifting ring



Adjustable 81 - 118 mm



## INSULATING DEVICE TO LIFT UP BATTERY

### Application:

- Insulated lifting device for LV live working.
- For batteries lifting during maintenance operations.

### Features:

- Maximum operating voltages: 1 000 V AC - 1 500 V DC
- Lifting device in accordance with machinery directive 2006/42/CE.
- Electrically tested according IEC 60900 standard.
- Adjustable fixing capacity from 81 to 118 mm.

Reference

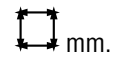

MO-810

160 x 130 x 50 mm.

0,6 kg



Unscrew the first battery terminal and place the first insulated plug in its place

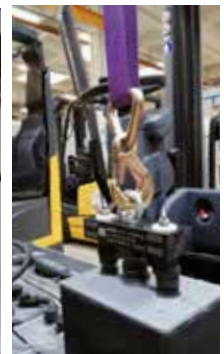

Unscrew the second battery terminal and place the second insulated plug in its place.





MO-69513  
RATCHET WRENCH WITH  
LOCKING SYSTEM



MO-69523  
EXTENSION



MO-69543  
«T» WRENCH



MO-69540  
EXTENSION

## RATCHETS AND ACCESSORIES

Square drive	1/4"	3/8"	1/2"
Ratchet	125 mm	190 mm	255 mm
	MO-69512	MO-69513	MO-69514
	170 mm	130 mm	125 mm
Extension		MO-69523	MO-69524
	MO-69522	250 mm	250 mm
		MO-69533	MO-69534
		130 mm	
«T» wrench	-	MO-69542	300 mm
		250 mm	
		MO-69543	MO-69544
Screwdriver handle	150 mm	-	-
	MO-69540		



## EXPANDER FEMALE TO MALE

### Application :

- Insulated expander for LV live working.

### Features :

- Insulated with orange hardened PVC
- Maximum operating voltages: 1 000 V AC - 1 500 V DC.



MO-69537

Reference	Female square	Male square	↔ (mm)	g
MO-69537	1/4"	3/8"	54	30
MO-69536	3/8"	1/2"	75	40



MO-69025



MO-69050



MO-69051



MO-69054

### ADJUSTABLE TORQUE WRENCH 3/8"

**Application:**

- Insulated adjustable torque wrench for LV live working.

**Features:**

- Maximum operating voltage: 1 000 V AC - 1 500 V DC.

Reference	↔ (mm)	$F_{Nm}$	
MO-69025	380	5 to 25	1.38
MO-69050	340	8 to 60	0.9
MO-69051	230	4 to 20	0.9
MO-69054	340	8 to 60	0.9

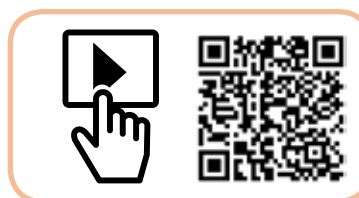

### 6 SIDES MALE SOCKET

	1/4"	3/8"	1/2"
3	MO-698M03	MO-69393	-
4	MO-698M04	MO-69394	MO-694M04
5	MO-698M05	MO-69395	MO-694M05
6	MO-698M06	MO-69396	MO-694M06
7	MO-698M07	MO-69397	-
8	MO-698M08	MO-69398	MO-694M08
10	-	MO-693100	MO-694M10
12	-	-	MO-694M12
14	-	-	MO-694M14
17	-	-	MO-694M17
19	-	-	MO-694M19



MO-698M03



### 6 - 12 SIDED INSULATING SOCKETS



MO-69408

	1/4"	3/8"	1/2"
4	MO-69804	-	-
5	MO-69805	-	-
5,5	MO-698055	-	-
6	MO-69806	MO-69306	-
7	MO-69807	MO-69307	-
8	MO-69808	MO-69308	MO-69408
9	MO-69809	MO-69309	MO-69409
10	MO-69810	MO-69310	MO-69410
11	MO-69811	MO-69311	MO-69411
12	MO-69812	MO-69312	MO-69412
13	MO-69813	MO-69313	MO-69413
14	MO-69814	MO-69314	MO-69414
15	-	MO-69315	MO-69415
16	-	MO-69316	MO-69416
17	-	MO-69317	MO-69417
18	-	MO-69318	MO-69418
19	-	MO-69319	MO-69419
21	-	MO-69321	MO-69421
22	-	MO-69322	MO-69422
23	-	MO-69323	MO-69423
24	-	MO-69324	MO-69424
25	-	-	MO-69425
26	-	-	MO-69426
27	-	-	MO-69427
28	-	-	MO-69428
29	-	-	MO-69429
30	-	-	MO-69430
32	-	-	MO-69432



### 3/8" TORX INSULATED SOCKET

**Application:**

- 3/8" TORX insulating socket for LV voltage live working.

**Features:**

- Maximum operating voltage: 1 000 V AC - 1 500 V DC.
- Orange PVC insulation.
- 3/8" square drive.
- 15 to 40 TORX, 50 RESISTORX.



MO-69T15

Reference		 (mm)
MO-69T15	Torx T15 ★	60
MO-69T20	Torx T20 ★	65
MO-69T25	Torx T25 ★	65
MO-69T30	Torx T30 ★	80
MO-69T40	Torx T40 ★	80
MO-69T50	Torx T50 ★	80



## 3/8" INSULATED TOOL SET



MO-69308/23

**Application:**

- Set of Insulated 3/8" tools for LV live working.

**Features:**

- Maximum operating voltage: 1 000 V AC - 1 500 V DC.
- Square drive 3/8".

**Composition :**

- 1 ratchet wrench 3/8" with mechanical locking MO-69513.
- 1 extension 3/8" length 140 mm MO-69523.
- 10 sockets 3/8" 6 sided from 8 to 23 mm.

Reference	Description	
MO-69308/23	3/8" socket wrench set with ratchet and extension in polypropylene case 410 x 120 x 75 mm	1.45 kg



MO-69314

Reference		
MO-69308	8 mm	0.03
MO-69310	10 mm	0.03
MO-69312	12 mm	0.033
MO-69313	13 mm	0.036
MO-69314	14 mm	0.042
MO-69317	17 mm	0.06
MO-69319	19 mm	0.69
MO-69321	21 mm	0.08
MO-69322	22 mm	0.095
MO-69323	23 mm	0.1
MO-69513	Ratchet	0.45
MO-69523	140 mm extension	0.12







## WRENCHES AND SPANNERS



MO-68006  
OPEN JAW SPANNER



MO-68106  
DEEP OFFSET WRENCH



MO-68206  
PIPE WRENCH

mm	Open jaw spanner	Deep offset wrench	Pipe wrench	
		12		
6	MO-68006	MO-68106	MO-68206	
7	MO-68007	MO-68107	MO-68207	
8	MO-68008	MO-68108	MO-68208	6
9	MO-68009	MO-68109	MO-68209	
10	MO-68010	MO-68110	MO-68210	
11	MO-68011	MO-68111	MO-68211	
12	MO-68012	MO-68112	MO-68212	
13	MO-68013	MO-68113	MO-68213	
14	MO-68014	MO-68114	MO-68214	
15	MO-68015	MO-68115	MO-68215	12
16	MO-68016	MO-68116	MO-68216	
17	MO-68017	MO-68117	MO-68217	
18	MO-68018	MO-68118	MO-68218	
19	MO-68019	MO-68119	MO-68219	
20	MO-68020	MO-68120	-	-
21	MO-68021	MO-68121	MO-68221	
22	MO-68022	MO-68122	MO-68222	6
23	MO-68023	MO-68123	MO-68223	
24	MO-68024	MO-68124	-	-
25	MO-68025	MO-68125	-	-
26	MO-68026	MO-68126	-	-
27	MO-68027	MO-68127	-	-
28	MO-68028	MO-68128	-	-
29	MO-68029	MO-68129	-	-
30	MO-68030	MO-68130	-	-
32	MO-68032	MO-68132	-	-



## INSULATING ADAPTOR

### Application:

- Insulating adaptor, with 1/4" hexagonal male fitting and 3/8" square drive.
- For use with electric screwdriver.

### Features :

- Operating voltage up to 1 000 V AC - 1 500 V DC.
- In accordance with IEC 60900 standard.
- No electrical continuity between the 1/4" fitting, and the 3/8" square drive for fitting on sockets.
- Maximum torque : 40 Nm.
- Fitting 1/4" male, hexagonal, on one side, for electric screwdriver. Length 20 mm.
- Square drive 3/8" male, on the other side, for mounting with 3/8" sockets.
- Maximum diameter on insulation: 20.5 mm.



MO-69522V

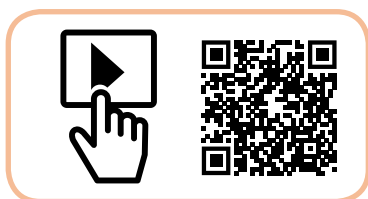

Reference

(mm)



MO-69522V

80

66



## INSULATED RATCHET WRENCH

### Application:

- Insulated ratchet wrench for LV live working.

### Features:

- Maximum operating voltage: 1 000 V AC - 1 500 V DC.



MO-69210



Reference

mm



10

MO-69210

9

0.29

13

MO-69213

11

0.45

17

MO-69217

16

0.55

19

MO-69219

18

0.70



MO-67501

## INSULATED CABLE CUTTER

**Application:**

- Insulated cable cutter for LV live working.

**Features:**

- Maximum operating voltage: 1 000 V AC - 1 500 V DC.
- Orange hardened PVC insulation.
- Special steel body.

Reference	↔ (mm)	∅	g
MO-67501	170	15	250
MO-67502	230	20	450

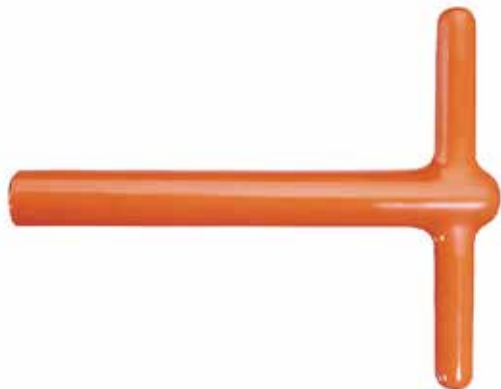

MO-68310

## T-HANDLE WRENCH

**Application:**

- T-Handle wrench for LV live working.

**Features:**

- Maximum operating voltage : 1 000 V AC - 1 500 V DC.
- 6 sided hexagonal female spanner.

↔ ∅	Length 140 mm	Length 300 mm	Length 400 mm
10	MO-68610	MO-68310	-
11	-	MO-68311	-
12	-	MO-68312	-
13	MO-68613	MO-68313	MO-68713
14	MO-68614	MO-68314	MO-68714
16	-	MO-68316	-
17	-	MO-68317	MO-68717
19	-	MO-68319	-
20	MO-68620	-	-
21	MO-68621	MO-68321	-
22	-	MO-68322	-



## ADJUSTABLE WRENCH



MO-69003

**Application:**

- Insulated adjustable wrench for LV live working.

**Features:**

- Maximum operating voltage: 1 000 V AC - 1 500 V DC.

Reference	Opening (mm)	↔ (mm)
MO-69003	28 mm	250
MO-69005	43 mm	390



## INSULATED BI-MATERIAL FLAT BLADE SCREWDRIVER



MO-72002

**Application:**

- Insulated screwdriver for LV live working.

**Features:**

- Maximum operating voltages: 1 000 V AC - 1 500 V DC.  
In accordance with DIN 5262 and ISO 8764 standards.

Reference	Description	□ mm.
MO-72002	Insulated slotted screwdriver 2.5 x 60 mm.	2.5 x 60
MO-72003	Insulated slotted screwdriver 3 x 100 mm.	3 x 100
MO-72004	Insulated slotted screwdriver 4 x 125 mm.	4 x 125
MO-72005	Insulated slotted screwdriver 5 x 150 mm.	5 x 150
MO-72006	Insulated slotted screwdriver 6 x 150 mm.	6 x 150
MO-72008	Insulated slotted screwdriver 8 x 175 mm.	8 x 175
MO-72010	Insulated slotted screwdriver 10 x 200 mm.	10 x 200



## INSULATED BI-MATERIAL POZIDRIV SCREWDRIVER

**Application:**

- Insulated screwdriver for LV live working.

**Features:**

- Maximum operating voltages: 1 000 V AC - 1 500 V DC.
- In accordance with DIN 5262 and ISO 8764 standards.



MO-72040

Reference	Description
MO-72040	PZ 0
MO-72042	PZ 1
MO-72044	PZ 2
MO-72046	PZ 3
MO-72048	PZ 4



## INSULATED BI-MATERIAL PHILLIPS SCREWDRIVER

**Application:**

- Insulated screwdriver for LV live working.

**Features:**

- Maximum operating voltages: 1 000 V AC - 1 500 V DC.
- In accordance with DIN 5262 and ISO 8764 standards.



MO-72030

Reference	Description
MO-72030	PH 0
MO-72032	PH 1
MO-72034	PH 2
MO-72036	PH 3
MO-72038	PH 4





## INSULATED BI-MATERIAL HEXAGONAL SCREWDRIVER



MO-68402

**Application:**

- Insulated screwdriver for LV live working.

**Features:**

- Maximum operating voltages: 1 000 V AC - 1 500 V DC.
- In accordance with DIN 5262 and ISO 8764 standards.

Reference	Description
MO-68402	2.5 mm X 75 mm length
MO-68403	3 mm X 75 mm length
MO-68404	4 mm X 100 mm length
MO-68405	5 mm X 100 mm length
MO-68406	6 mm X 125 mm length
MO-68408	8 mm X 150 mm length



## INSULATED BI-MATERIAL TORX SCREWDRIVER



MO-720510

**Application:**

- Insulated screwdriver for LV live working.

**Features:**

- Maximum operating voltages: 1 000 V AC - 1 500 V DC.
- In accordance with DIN 5262 and ISO 8764 standards.

Reference	Description
MO-72056	TORX T6 x 50 mm
MO-72057	TORX T7 x 50 mm
MO-72058	TORX T8 x 50 mm
MO-72059	TORX T9 x 75 mm
MO-720510	TORX T10 x 75 mm
MO-720515	TORX T15 x 75 mm
MO-720520	TORX T20 x 100 mm
MO-720525	TORX T25 x 100 mm
MO-720527	TORX T27 x 115 mm
MO-720530	TORX T30 x 125 mm
MO-720540	TORX T40 x 125 mm
MO-720545	TORX T45 x 150 mm
MO-720550	TORX T50 x 175 mm



## INSULATION TORQUE SCREWDRIVER



MO-7200DYN

### Application:

- Low voltage live working.
- Controlled torque tightening.

### Features:

- Maximum operating voltage: 1 000 V AC - 1 500 V DC.
- Torque range: 0.8 to 5 Nm
- Accuracy:  $\pm 6\%$ .
- Bits locking system.
- Including a calibration tools and a calibration certificate.
- Bits not including.

Reference	$\vec{F}_{Nm}$	$\longleftrightarrow$ (mm)	 g
MO-7200DYN	0.8 to 5	190	290



## INSULATED BITS FOR MO-7200-DYN TORQUE SCREWDRIVER



MO-7200-PH2



MO-7200-PZ1



MO-7200-PZ2



MO-7200-SL4



MO-7200-SL55

### Application:

- For live working on low voltage.
- To be only used with the MO-7200-DYN.

### Features:

- Operating voltage: 1 000 V AC - 1 500 V DC.

Reference	Description	$\longleftrightarrow$ (mm)	 g
MO-7200-PH2	PHILLIPS PH2	75	30
MO-7200-PZ1	POZIDRIV PZ1	75	30
MO-7200-PZ2	POZIDRIV PZ2	75	30
MO-7200-SL25	FLAT BLADE 2.5 mm	75	25
MO-7200-SL4	FLAT BLADE 4 mm	75	30
MO-7200-SL55	FLAT BLADE 5.5 mm	75	35
MO-7200-T15	TORX T15	75	25
MO-7200-T20	TORX T20	75	30
MO-7200-T25	TORX T25	75	35



MO-66000C



MO-66303C



MO-66404CC

## INSULATING PLIERS

### Application:

- Insulating bent nose pliers for live working at low voltage.

### Features:

- Maximum operating voltage: 1 000 V AC - 1 500 V DC.
- Fully insulating orange composite material.
- Ceramic cutters.

Reference	Description	↔ (mm)	 g
MO-66000C	Universal plier	200	150
MO-66303C	Flat nose plier	190	110
MO-66404CC	Bent flat nose plier	210	150

**BI-MATERIAL INSULATED TOOLS KIT****Application:**

- Insulated tools for LV live working.

**Features:**

- Maximum operating voltage : 1 000 V AC - 1 500 V DC.

**Composition:**

- 3 flat blade screwdrivers: MO-72004 (4x125 mm) - MO-72006 (6x150 mm) - MO-72008 (8x175 mm).
- 2 Pozidriv screwdrivers: PZ1 MO-72042 - PZ2 MO-72044.
- 1 wire stripping pliers MO-72172.
- 1 bent snipe nose pliers MO-72142.
- 1 cable cutter pliers MO-72200.



KIT-24

Reference	Composition	Description
KIT-24	MO-72004	Flat blade 4 x 125 mm
	MO-72006	Flat blade 6 x 150 mm
	MO-72008	Flat blade 8 x 175 mm
	MO-72042	POZIDRIV screwdriver N ° 1
	MO-72044	POZIDRIV screwdriver N ° 2
	MO-72172	End stripping pliers 160 mm
	MO-72142	Bent snipe nose pliers 160 mm
	MO-72200	Cable cutter 160 mm

**MAGNET ON FLEXIBLE HANDLE****Application:**

- Magnet on flexible handle for LV live working.

**Features:**

- Operating voltage up to : 1 000 V AC - 1 500 V DC.
- Entirely insulated.
- Magnet diameter : 14,5 mm.
- Maximum load to the magnet : 1 kg.



MO-7582-D

Reference	↔ (mm)	⚠ g
MO-7582-D	470	200



MO-745D

## INSULATED DEAD-BLOW HAMMER

**Application:**

- Insulated hammer for LV live working.

**Features:**

- In accordance with IEC 60900 standard.
- Maximum operating voltage up to : 1 000 V AC - 1 500 V DC.
- 2 interchangeable insulated striking head of diameter 35 mm.
- Dead-blow system.

Reference



(mm)



MO-745D

310 x 120 x 40

800



MO-755D

## INSULATED MIRROR

**Application:**

- Insulated mirror for LV live working.

**Features:**

- Maximum operating voltage : 1 000 V AC - 1 500 V DC.
- Mirror diameter : 22 mm.

Reference



MO-755D

22 mm

20



MO-710D

## INSULATING BRUSH

**Application:**

- Insulated brush for LV live working.

**Features:**

- Maximum operating voltage : 1 000 V AC - 1 500 V DC.

Reference

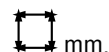

mm.



MO-710-D

420 x 38

80





MO-61001



MO-61002



## INSULATED KNIVES

**Application:**

- Insulated knives for LV live working.

**Features:**

- Maximum operating voltage: 1 000 V AC - 1 500 V DC.
- Grey insulating material with SOFT touch on the handle.

Reference	←→ (mm)	 mm	 g
MO-61001	180	62	100
MO-61002	180	50	100



## ELECTRICIAN TOOL BAG

**Application:**

- Bag to carry/store tools, accessories, etc.

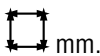

M-87303

Reference	 mm.	 kg
M-87303	440 x 330 x 160	0,82

## TEXTILE TOOL BOX

**Application:**



- Tool box to carry/store tools, accessories, etc.

**Features:**

- 1 removable partition.16 pockets for tools.
- 9 storage pockets for tools on the external side of the tool box.
- Rubber reinforcements on the bottom.

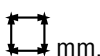

MO-39

Reference	 mm.	 kg
MO-39	480 x 320 x 230	0.9





M-882452

## STORAGE BOXES FOR ACCESSORIES AND TOOLS

### Application:

- To store, stock or transport material.

Reference	 mm.	 kg
M-882452	500 x 280 x 250	1,1

## TOOL BAG WITH REINFORCED BASE





MO-42/1

### Application:

- Bag to carry/store tools, accessories, etc.

### Features:

- Metal wire framing structure, allowing an immediate access to the bag content.
- Numerous interior and exterior pockets for a high storage capacity.
- Zip closure with metal slider.
- Rigid plastic abrasion-resistant bottom and ensuring great stability of the bag in the open position.

Referene	 mm.	 kg
MO-42/1	320 x 240 x 170	0,70
MO-42/2	400 x 270 x 220	0,80



MO-44

## BACKPACK WITH WHEELS FOR ELECTRICIAN

### Application:

- Ergonomic wheeled backpack, reducing musculoskeletal disorders (MSD).
- Perfectly fitted for transport and storage of the tool kits, laptop and helmet.
- Provides 3 modes of carrying: hand, wheels or back.

### Features:

- Ergonomic foamed shoulder straps, with possibility to store them in a special pocket for not dragging on the ground.
- Foam-filled protection reinforcements for a better back and lumbar comfort.
- High-strength and silence-proof wheels – non replaceable.
- Telescopic adjustable handle 2 heights.

Reference

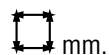

Volume

MO-44

460 x 330 x 240

3,2

30 L





## SIGNS / LOCK-OUT / TAG-OUT REGULATORY SIGNS

ACA-10



### MAGNETIC SIGNAL PYRAMID “ELECTRIC HAZARD” TO WORK ON EHV OR BATTERIES

**Application:**

- Positioned on the roof of an electric vehicle or on metallic part, it allows an optimum 360° visualization of the electric danger.

**Features:**

- Installation and removal made easy thanks to the magnetic base with strong adhesion in a triangular shape (140 mm side).
- Delivered flat (pattern): the user easily assembles the sides, thanks to adhesive strips already placed on the product.

Reference

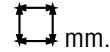

mm.

ACA-10

When the structure is not assembled:  
side 350 mm. Assembled triangular face frame:  
170 mm side.



AP-550-M2V



AP-550-M3



AP-72

### PLASTIC POSTER FOR HEV

Reference

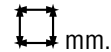

mm.

Use

AP-550-M2V

150 x 450 x 4

Suction cups

AP-550-M3

150 x 450 x 4

Magnetic support

AP-72

150 x 450 x 4

Support for boundary post



## SET OF 40 TEMPORARY STICKERS « DAMAGED VEHICLE » FOR HEV



AT-81

### Application:

- Temporary sticker to place on the windows or the windscreen of the damaged electric and hybrid vehicles.
- Helps to keep people informed of the danger.
- Easy to remove after the towing and the repair of the vehicles.

Reference

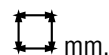

AT-81

280 x 110

40



AM-20-B

## ALUMETAL™ WARNING SIGN

Reference



Num.  
Holes

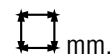

AM-20 GB

Diam. 4.5 mm

4

500 x 350 x 1

## ADHESIVE PLASTIC POSTER FOR HEV A4 FORMAT

### Application :

- Signal of the safety rules for operation on electrical or hybrid vehicle.

### Features :

- Hanging with adhesive strips included or mounting holes.



ATP-551-B

Reference

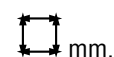

ATP-551-B

210 x 297 x 1





## FOLDING SAFETY BARRIER



AL-326

- Application:**
- Allows temporarily delineation of a working area.
  - For indoor use.
- Features:**
- Modularity: possibility to add or remove panels.
  - Highly visible with the fluorescent yellow colour.

Reference	mm.	kg
AL-325	3 panels : 1710 x 1000	3,2
AL-326	1 panel (extension) : 570 x 1000	1,4



AL-325



AL-316



AL-318



AL-323



AL-324



AL-328

## BOUNDARY POST FOR DELINEATION OF A WORKING AREA

- Application :**
- Boundary post enables delineation and signaling of a working area.
  - Outdoor and indoor use.
  - Can be completed with AL-3...-chain.

Reference	Composition	mm.	kg
AL-316	Foldable. Ballasted base.	Post : Ø 50 x 900 Base : 280 x 280 x 70	4
AL-318	Foldable. Ballasted base.	Post : Ø 50 x 900 Base : 280 x 280 x 70	4
AL-323	Ballasted base.	Post : Ø 50 x 900 Base : 280 x 280 x 50	2,9
AL-324	Ballasted base.	Post : Ø 50 x 900 Base : 280 x 280 x 50	2,9
AL-328	With retractable strap. Ballasted base.	Total height 1 m Tape: 1 50 mm x L 4 m	8



AL-31/25



AL-32/25

## PLASTIC CHAIN

### Application:

- For any signaling or delineation operation.
- To be completed with AL-3...-post.

### Features:

- Chain with plastic openable links.
- Chain link diameter: 8 mm.
- Chain link dimensions: 70 x 27 mm.

Reference	Composition	↔ (mm)	Color	kg
AL-31/05	chain links	5000		0,55
AL-31/25	chain	25000		2,5
AL-32/05	chain	5000		0,55
AL-32/25	chain	25000		2,5
AL-31	5 red & 5 white chain links	52		0,05





Adhesive



AT-5005



AL-139

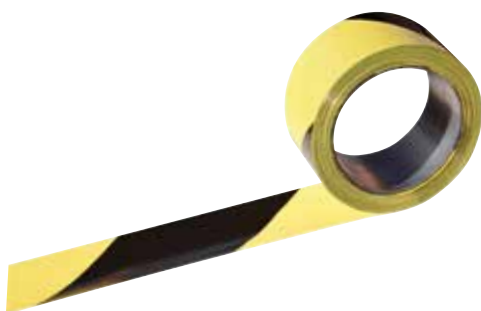



AL-140

### SIGNALING / DELINEATION TAPE

**Application:**

- Allows temporarily delineation of a working area.
- For indoor and outdoor use.

Reference	Color	Marking	Description
AT-5005		Oblique bands	Adhesive tape 100 x 50 m
AL-139		Oblique bands	Plastic edge tape 100 m x 50 mm.
AL-140		Oblique bands	Plastic edge tape 100 m x 50 mm.



## LOCKING

### LOCK-OUT / TAG-OUT



SL-101



SL-102



## LOCKOUT STATION

### Application:

- Allows the storage of the lockouts.

### Features:

- Transparent door.
- Locked by key.
- Delivered without padlock or lockout.

Reference	Colour		 mm.	 kg
SL-101	Yellow	-	405 x 355 x 156	5,6
SL-102	Red	42	465 x 395 x 55	4,5

## GROUP LOCK BOX

### Application:



- Device for storing the keys of safety padlocks.
- Prevents unintentional re-energization while operators are working on the equipment.

### Features:

- 12 slots available to place the safety padlocks of team members.
- Key slot to insert an additional key if other power sources have to be isolated after the maintenance work has started.
- Internal quick-release button to lock/unlock the supplied wall base for both portable and fixed applications.



SL-106

Reference		 mm.	 kg
SL-106	12	240 x 174 x 40	1



## SAFETY PADLOCK

### Application :

- For locking the separating devices (e.g. circuit breakers) to prevent their operation.
- More secure locking: impossible to drop the key when the shackle is open, the key remains trapped.

### Features :

- Available with a keys different (Z).
- Padlock delivered with 2 keys.



PM/PP-4/6-38-R-Z

Reference	Color		Shackle	
			Ø (mm)	Material
PM-4-38-R-Z	■	Z	4	Metal
PM-6-38-R-Z	■	Z	6	Metal
PP-4-38-R-Z (*)	■	Z	4	Nylon
PP-6-38-R-Z	■	Z	6	Nylon

(\*) Unique on the market.



AP-460



## PLASTIC WARNING SIGN (SET OF 10 UNITS)

### Application :

- Safety Tag-Out badge with warning sign “ELECTRIC SHOCK” and “DO NOT SWITCH ON”.

### Features :

- Made of flexible plastic.
- Two-sided printing.
- Supplied by set of 10 badges.

Référence	Ø (mm)	 mm.	
AP-460	1 x 10 mm	120 x 70	0,022





ALPV-L-D

### STEERING WHEEL COVER

**Application:**

- Provides an ideal lock for steering wheel.
- Allows to display a personalized message during the lock-out procedure thanks to the transparent pocket (A5 size).

**Features:**

- Strap closure at the back with metal eyelets Ø 10 mm for inserting a padlock and self-gripping part.

Reference	Description	g
ALPV-L-D	Locking cover for steering wheel (up to Ø 42 cm)	150
ALPV-XL-D	Locking cover for steering wheel (up to Ø 62 cm)	200



### ELECTRICAL PLUG LOCKOUT

**Application:**

- Suitable for lock-out electrical or pneumatic plugs.
- Prevents the equipment from being inadvertently re-energized.



PL-101

PL-100

Reference	Ø mm		Ø mm	mm.	g
PL-100	2	9	12 mm	85 x 75 x 50	78
PL-101	4	9	25 mm	171 x 102 x 80	222



PL-102

### OVERSIZED PLUG AND HOIST CONTROL LOCKOUT

**Application:**

- In red fabric and black leather.
- Device for blocking remote control of numerical machines, cranes, bridge cranes.
- Locking with padlocks.

Reference		$\varnothing$ mm	mm.	g
PL-102	6	11	460 x 210	65 g



IEC / EN 60900



### INSULATING TOOL WITH WEDGE-SHAPED BLADE

**Application:**

- Insulating tool for LV live working.
- Especially allows to open the plastic covers.

**Features:**

- Maximum operating voltage: 1 000 V AC - 1 500 V DC.
- Fully insulating.



MO-600

Reference	(mm)	g
MO-600	250	150



## TEST AND MEASUREMENT VOLTAGE DETECTORS



MS-917-L

EN 61243-3 (2015) / EN 50110-1  
IEC 61010-1 / IEC 61010-031



### LOW VOLTAGE DETECTOR DETEX

**Application:**

- Check the presence of voltage up to 900 V AC, 1 000 V DC according to the model.
- Sound and light continuity for a dead circuit. (threshold of 200 Ohm).
- Unipolar phase identification.
- Search for the polarities of a DC circuit.
- For indoor / outdoor use.

**Features:**

- Total safety with hazardous voltage indicator light (> 50 V).

**Optional accessories:**

- Carrying bag with belt loop: M-87285.
- Holder: M-952325.

Reference								
	Hz	Voltage AC	Voltage DC	Threshold Nbr	Category	Rotary field	Lighting	Continuity
MS-917-L	50/60	12 - 690	12 - 750	8	600 V			200 Ω
MS-918-L	50/60	12 - 900	12 - 1 000	8	600 V	•	•	100 Ω

NF EN 61 326-1 / NF EN 62311 / NF EN 61243-3



### AC AND DC VOLTAGE CONTROLLER

**Application:**

- Ergonomically optimized voltage controller, ideal for use in tight spaces thanks to its electrode extensions (250 mm and 500 mm).
- It provides a wide detection voltage range: from 50 to 4 200 V DC and from 50 to 3 000 V AC.

**Features:**

- Maximum nominal voltage: 3 500 V DC, 2 500 V AC.
- Detection voltage: 50 to 4 200 V DC, 50 to 3 000 V AC.



MS-415

Référence		
MS-415	550 x 160 x 50	0,78



### CONTACT PROBES FOR L.V. DETECTORS DETEX MS-917 AND MS-918

**Application:**

- Contact probes to be used as suspension hooks (MS-8014), round tip contact (MS-8013).
- Light and rigid contact probes for Detex: MS-917 fitted with touch point with elastic cage test.
- Hatch for storage of test probe.

**Composition:**

- Supplied in soft case.



MS-8013

MS-8014

Reference	↔ (mm)	kg
MS-8013	500	0,29
MS-8014	1 250	0,63

Delivered in a case



Hatch for storage of test probe.



MX-701

### DIGITAL MULTIMETER

**Application:**

- MX-701 Multimeter. Measures DC and AC voltages, AC and DC current, resistance, inductance, temperature. Test of diodes and open circuits (audible alarm).



- \* 2 test probes with angled connector IP2X
- \* 1 thermometric probe

Reference	AC	DC	10 Hz - 10MHz	600 $\mu$ A to 10 A AC/DC	600 $\Omega$ to 60 M $\Omega$	10 nF to 100 $\mu$ F	Class III	0°C to 40°C
<b>MX-701</b>	600 mV-750 V AC	600 mV - 1000 V	10 Hz - 10MHz	600 $\mu$ A to 10 A AC/DC	600 $\Omega$ to 60 M $\Omega$	10 nF to 100 $\mu$ F	III	III 1 000 V IV 600 V
	-20 to 1 000°C 0 to +1 800°F	188 x 88 x 54 mm	0,32 kg	Batteries	2 x AA LR06 1,5 V	2 probes	LCD 3+1/2 digits	







MX-704

## INFRARED THERMOMETER

### Application:

- MX-704 High performance infrared thermometer, suitable for detecting abnormal hot spots in electrical installations. Automatic measurement of the target temperature (°C and/or °F) without knowing the emissivity of the material or surface properties.

Reference	 mm.	 kg	Batteries
<b>MX-704</b>	130 x 180 x 40	0,195	1 battery 9 V 6LR61

\* Delivered with battery and a flexible case with a wrist strap

IEC EN 61010-031



DX-02003

## IP2X SAFETY CORDS FOR TEST LEAD POINTS

### Application:

- Safety cords for test lead points for measuring devices.

### Features :

- Hand guard (for test lead points ).
- Compatible with sheathing standard Ø 4 mm connections.
- Retractable sheath. Contact point on elastic cage Ø 4 mm.
- Double-insulated flexible wires 1.20 m length and 1 mm<sup>2</sup> cross section on Ø 4 mm IP2X elbow end pieces.



DX-02004

Reference	Description
<b>DX-02003</b>	Set of 2 cables BLACK and RED IP2X 4 mm straight male / angled male
<b>DX-02004</b>	Set of 2 cables BLACK and RED IP2X 4 mm male / male with rear female socket



## IP2X SAFETY ALLIGATOR CLIPS



DX-02006

### Features:

- IP2X safety alligator clips, with hand guard.
- Clamping capacity: Ø 16 mm or 22 mm conductor on flats (M14 nut type).
- Compatible with standard Ø 4 mm plugs.

### Composition:

- CX-01222 : alligator clip brown.
- CX-01422 : alligator clip yellow.
- CX-01822 : alligator clip green.
- DX-02006 : 2 alligator clips black and red.

Reference	Comp.	description
DX-02006	CX-01222	alligator clip brown
	CX-01422	alligator clip yellow
	CX-01822	alligator clip green
	DX-02006	2 alligator clips black and red



## IP2X SAFETY TEST LEAD POINTS AND CORDS



DX-02002

### Application:

- Safety test lead points for measuring devices.

### Features :

- Hand guard (for test lead points).
- Compatible with standard Ø 4 mm connections.
- Retractable sheathing. Contact point on elastic cage Ø 4 mm.

Reference			
DX-02002	max 20 A	III 600 V	1 000 V AC 1 500 V DC



M-87285



M-87290



M-87292





MO-43

## BAGS

### Application:

- Bag to carry/store tools, accessories, etc.
- M-87285 : Suitable for the MS-917 voltage detector.

Reference	 mm.	 g
M-87285	260 x 90 x 55	96
M-87290	200 x 120 x 50	120
M-87292	230 x 190 x 70	300
MO-43	280 x 200 x 80	300



## KITS KITS

- CATU helps operators to select the right material before working on EHV.
- CATU kits are classified by trade or by operation.



	Trade	Vehicle repair	Expert vehicle repair	MOT or technical control	Road assistance	Going in a training
Operation		KIT-VEH-G-PRO	KIT-VEH-G-EXP	KIT-VEH-TEC	KIT-VEH-DEP	
Delineation	KIT-VEH	•	•			
Lock-Out Tag-Out	KIT-VEH-C	•	•			
Work in the vicinity or under voltage	KIT-VEH-V-TST		•			
Essential set for personal protection	KIT-VEH-PPE	•	•		•	
Comprehensive set for personal protection mandatory for training	KIT-VEH-PPE/02					•
Other		- Signaling damaged vehicle (AT-81)	- Signaling damaged vehicle (AT-81)	- Essential set for personal protection with helmet - Signaling HEV (ACA-10)	- Signaling damaged vehicle (AT-81) - Essentials for Lock-Out Tag-Out (PP-6-38-R-Z & AP-460)	



### DELINEATION KIT

Reference	Composition	Quant.	Description
KIT-VEH	AL-323	6	Safety boundary post with ballasted base
	AL-31/25	1	Boundary chain, red and white, length 25 m
	AP-72	2	Warning sign, fitting with AL-323 post



AL-323



AL-31/25



AP-72

**KIT-VEH-C**

## KIT FOR LOCK-OUT TAG-OUT OPERATIONS

### Application :

- Suitable for lock-out tag-out operations on electric and hybrid vehicles and machines.

Reference	Composition	Quant.	Description
	ACA-10	1	Magnetic signal pyramid "Electric Hazard" to work on HEV or batteries
	AP-550-M2V	1	Tag Out plastic sign for HEV with suction cups. 450 x 150 mm
	ATP-551-B	1	Adhesive plastic poster for HEV A4 format
<b>KIT-VEH-C</b>	PP-6-38-R-Z	1	Insulated safety padlock, nylon shackle 38 mm, diameter 6 mm
	AP-460	10	Set of 10 safety Tag-Out badges with warning sign 120 x 70 mm
	MS-917-PG	1	Low Voltage detector DETEX (1 000 V DC)
	MO-600	1	Insulating tool with wedge-shaped blade



**NEW!**



KIT-VEH-PPE 02

## COMPLETE PPE KIT FOR TRAINING WITH HEAD, BODY, HAND PROTECTION

### Application:

- Full kit of PPE for dead and live working on electric and hybrid vehicle battery. Switching jacket included.

Reference	Composition	Quant.	Description
KIT-VEH-PPE/02	MO-286	1	Arc-flash face shield with headband for electrician
	M-87384	1	Face shield - Arc Flash GS-ET-29: class 1 with protective cover
	CG-10-C	1	Insulating gloves, class 0 (1 000 V AC / 1 500 V DC), size 10
	CG-981-10	1	Leather over gloves for the mechanical protection of insulating gloves, size 10
	AFG-2300-2XL	1	Arc flash CAT'ARC jacket, size 2XL
	MO-50	1	Bag



KIT-VEH-PPE

## ESSENTIAL PPE KIT

### Application :

- Suitable for electric and hybrid vehicles and machines operations.
- Face protection with face shield: protection against short-circuit arcs.
- Protection of the hands with the use of undergloves, insulating gloves and overgloves: electric shocks up to 1000 V AC and mechanical protection.

Reference	Composition	Quant.	Description
	MO-286	1	Face shield - Arc Flash GS-ET-29: class 1
	M-87-384	1	Protective covers for faceshield
KIT-VEH-PPE	CG-0-10-R-28	1	Short insulating gloves (28 cm), IEC 60903 class 0, size 10, 1 000 V AC - 1 500 V DC
	CG-80-H	1	Cotton undergloves for insulating gloves
	CG-984-10	1	Leather overgloves to ensure mechanical protection for insulating gloves, size 10
	CG-36/1	1	Storage pouch for gloves

## INSULATED TOOLS KIT INCLUDING A DIGITAL MULTIMETER AND RECUE STICK FOR LIVE WORKING

### Application:

- Suitable for electric and hybrid vehicles and machines operating.
- Suitable for work in the vicinity or under voltage (maximum operating voltage 1 000 V AC – 1 500 V DC).



KIT-VEH-V-TST

KIT-VEH-V-TST

Reference	Composition	Quant.	Description
	MP-220	1	Insulating orange blanket class 0, 1x1 m
	MP-627-D	3	Small model clamp for blanket
	MP-635/15-D	4	Insulating cap class 0, Ø 15 mm
	MP-635/30-D	4	Insulating cap class 0, Ø 30 mm
	MP-635/60-D	2	Insulating cap class 0, Ø 60 mm
	MP-19/1	1	Wide red electrical adhesive insulating tape 50 m x 50 mm
	MP-29/3-S	1	Insulating bag
	AT-67/1	20	Warning sticker "BATTERY HAZARD" 100 mm
	MX-701	1	Digital multimeter TRMS
	CS-45/2	1	Rescue stick with insulated permanent hook 45 kV - 1,65 m
	MO69308/HAT-D	1	Set of sockets 3/8"
	MO-66000C	1	Insulating universal plies
	MO-710-D	1	Insulated brush
	MO-755-D	1	Insulated mirror
	KIT-23	1	5 bi-material screwdrivers kit
	MO-69213	1	Insulated ratchet wrench
	MO-7582-D	1	Magnet on flexible handle
	MO-67501	1	Insulated cable cutter
	MO-69051	1	Insulated torque wrench 3/8" 4-20 Nm

## HEAD AND HAND PROTECTION KIT FOR SAFE INSPECTIONS

### Application:

- Suitable for electric and hybrid vehicles and machines.
- Hand protection with insulating gloves, head protection with insulated helmet. Easy to store in the CATU bag.



KIT-VEHC-TEC

Reference	Composition	Quant.	Description
	MO-185-BL	1	Insulated helmet with retractable screen
	M-87-384	1	Protective covers for helmets and visors. 440 x opening Ø 435 mm
	CG-0-10-R-28	1	Short insulating gloves (28 cm), class 0, size 10, 1 000 V AC - 1 500 V DC
KIT-VEHC-TEC	CG-80-H	1	Cotton undergloves for insulating gloves
	CG-984-10	1	Leather overgloves to ensure mechanical protection for insulating gloves, size 10
	CG-36-1	1	Storage case for insulating gloves
	ACA-10	1	Signal pyramid (3 sides) with magnetic base
	MO-42/2	1	Bag to carry/store tools, accessories, etc.

## HEAD AND HAND PROTECTION KIT INCLUDING SIGNALING

### Application:

- Suitable for electric and hybrid vehicles and machines.
- Hand protection with the insulating gloves.
- Head protection with an Arc-Flash face shield.
- Universal signaling and insulated padlock.
- Easy to store in a CATU bag.



KIT-VEH-DEP

Reference	Composition	Quant.	Description	
KIT-VEH-DEP	KIT-VEH-PPE	MO-286	1	Faceshield - Arc Flash GS-ET-29: class 1
		M-87-384	1	Protective covers for helmets faceshield
		CG-0-10-R-28	1	Short insulating gloves (28 cm), IEC 60903, class 0, 1 000 V AC - 1 500 V DC
		CG-80-H	1	Cotton undershoves for insulating gloves
		CG-984-10	1	Leather overgloves to ensure mechanical protection for insulating gloves, size 10
		CG-36-1	1	Storage case for insulating gloves
AT-81		1	Set of 40 temporary stickers "Damaged vehicle"	
PP-6-38-R-Z		1	Insulated safety padlock, nylon shackle, Ø 6 mm	
AP-460		1	Set of 10 safety Tag-Out badges	
MO-42/2		1	Bag to carry/store tools, accessories, etc.	

## HEV VEHICLE REPAIR KIT

### Application :

- Protective equipments against electrical risk.
- Suitable for operator working on electric and hybrid vehicles.
- For delineation, Lock-Out, and signaling.



KIT-VEH-GPRO

Reference	Comp.	Quant.	Description
KIT-VEH	AL-323	6	Balasted boundary posts red and white
	AL-31/25	1	Plastic chain with red and white links 25 m
	AP-72	2	Plastic signs. Dimensions 450 x 150 mm.
KIT-VEH-PPE	MO-286	1	Face shield - Arc Flash GS-ET-29: APC1
	M-87-384	1	Protective bag for face shield.
	CG-0-10-R-28	1	Pair of short insulating gloves (28 cm), class 0 (1 000 V AC / 1 500 V DC), size 10
	CG-80-H	1	Pair of cotton under-gloves
	CG-984-10	1	Pair of leather overgloves for the mechanical protection of insulating gloves, size 10, protection against thermal risks (EN 407)
KIT-VEH-GPRO	CG-36-1	1	Glove storage bag
	AT-81	1	Set of 40 "DAMAGED VEHICLE" stickers.
KIT-VEH-C	ACA-10	1	3-sided magnetic warning pyramid
	AP-550-M2V	1	Warning sign with suction cups
	ATP-551-B	1	Adhesive plastic poster: Golden Rules
	PP-6-38-R-Z	1	Safety padlock with insulating shackle Ø 6 mm
	AP-460	10	Safety Tag-Out badges
	MS-917-PG	1	LED voltage detector 1 000 V DC
	MO-600	1	Insulating wedge tool suitable for maintenance operations on electric vehicle batteries, especially for disconnection.



## HEV VEHICLE REPAIR KIT

### Application :

- Protective equipment against electrical risk.
- Suitable for operator working on electric and hybrid vehicles.
- For delineation, Lock-Out signaling, and working in the vicinity of voltage or working live.



KIT-VEH-GEXP

Reference	Comp.	Quant.	Description
KIT-VEH	AL-323	6	Balasted boundary posts red and white
	AL-31/25	1	Plastic chain with red and white links 25 m
	AP-72	2	Plastic signs. Dimensions 450 x 150 mm.
KIT-VEH-PPE	MO-286	1	Face shield - Arc Flash GS-ET-29: APC 1
	M-87-384	1	Protective bag for face shield.
	CG-0-10-R-28	1	Pair of short insulating gloves (28 cm), class 0 (1 000 V AC / 1 500 V DC), size 10
	CG-80-H	1	Pair of cotton under-gloves
	CG-984-10	1	Pair of leather overgloves for the mechanical protection of insulating gloves, size 10, protection against thermal risks (EN 407)
KIT-VEH-GEXP	CG-36-1	1	Glove storage bag
	AT-81	1	Set of 40 "DAMAGED VEHICLE" stickers.
KIT-VEH-C	ACA-10	1	3-sided magnetic warning pyramid
	AP-550-M2V	1	Warning sign with suction cups
	ATP-551-B	1	Adhesive plastic poster: Golden Rules
	PP-6-38-R-Z	1	Safety padlock with insulating shackle Ø 6 mm
	AP-460	10	Safety Tag-Out badges
	MS-917-PG	1	LED voltage detector 1 000 V DC
	MO-600	1	Insulating wedge tool suitable for maintenance operations on electric vehicle batteries, especially for disconnection.

CONTINUED ON NEXT PAGE



CONTINUED FROM PREVIOUS PAGE



KIT-VEH-GEXP

KIT-VEH-V-TST

Reference	Comp.	Quant.	Description
	MP-220	1	Insulating flexible mat IEC 61112 Class 0; dimensions: 1 x 1 m
	MP-627-D	3	Insulating clamps for fastening elastomer or plastic insulating or protective blankets. Length: 80 mm
	MP-635/15-D	4	Insulating cap Ø: 15 X 100 mm
	MP-635/30-D	4	Insulating cap Ø: 30 X 120 mm
	MP-635/60-D	2	Insulating cap Ø: 60 x 140 mm
	MP-19/1	1	Red insulating adhesive tape. Dimension: 50 m x 50 mm
	MP-29/3-S	1	Insulating cover. Dimension: 305 x 225 mm
	AT-67/1	20	Self-adhesive warning sign «WARNING ! BATTERY CHARGING». Side of 10 cm
	MX-701	1	CAT III 1000 V multimeter TRMS with LCD digital display for measuring AC and DC voltages, AC and DC currents as well as resistances, capacitances and temperature
	CS-45/2	1	Rescue stick 45 kV 1.65 m with insulated hook
	MO69308/HAT-D	1	Socket set 3/8" with ratchet and extension bar (140 mm) in case. Female hex sockets: 8-10-12-13-14-17-19-21-22-23; male hex sockets: 3-4-5-6-8; Torx sockets: TX15-TX20-TX30-TX40-TX50
	MO-710-D	1	Insulating brush
	MO-755-D	1	Insulating mirror
	KIT-23	1	Insulated screwdriver set for live working. Flat-blade screwdriver: 4-6-8 mm; Pozidriv screwdriver: PZ1, PZ2. IEC 60900
	MO-72142	1	Bent snipe nose plier 160 mm. IEC 60900
	MO-7582-D	1	Magnet insulated gripping tool mounted on flexible shaft
	MO-67501	1	Insulated cable cutter 170 mm. IEC 60900
	MO-69051	1	3/8" insulated reversible torque wrench. Torque: 4 to 20 N.m. IEC 60900



### After Sales Services

- xavier.lebec@catuelec.com
- Phone: +33 (0)1 42 31 46 85
- latif.ozmen@catuelec.com
- Phone: +33 (0)1 42 31 46 86

### Technical Assistance

- corinne.peigne@catuelec.com
- Phone: +33 (0)1 42 31 46 24
- charles.saulnier@catuelec.com
- Phone: +33 (0)1 42 31 63 10

The characteristics and technical informations stated in our literature are only for your guidance and therefore cannot be considered as contractual. our company is entitled to modify at any time the characteristics of its equipment.

In case of modification of these characteristics, our company would not be obliged to supply materials conform to those previously in force.



© 2022 CATU SAS BAGNEUX

**All reproduction, adaptation and translation rights reserved for all countries.**

## DISCOVER OUR MAIN PUBLICATIONS :



Catalogue commercial & Industry



Railways solutions

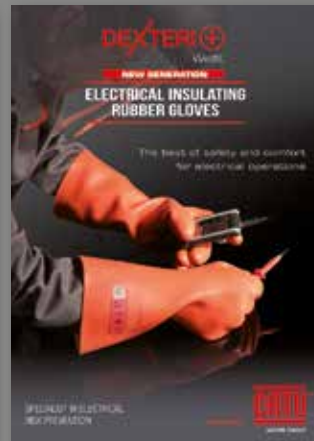

Insulating gloves

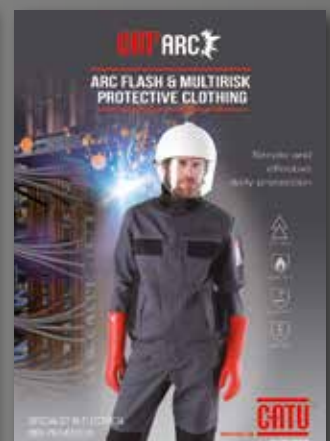

CAT'ARC Protective clothing

Distributed by:



10, avenue Jean-Jaurès – 92 222 Bagneux, France  
Phone: +33 (0)1 42 31 46 00 - Fax : +33 (0)1 42 31 46 32  
Phone business: +33 (0)1 42 31 46 08

[www.catuelec.com](http://www.catuelec.com)

**CATU™**  
SICAME GROUP